

Overview of previous and current lectures

- **Locks create serial code**
 - Serial code gets no speedup from multiprocessors
- **Test-and-set spinlock has additional disadvantages**
 - Lots of traffic over memory bus
 - Not fair on NUMA machines
- **Idea 1: Avoid spinlocks**
 - We saw lock-free algorithms last lecture
 - Mentioned RCU last time, dive deeper today
- **Idea 2: Design better spinlocks**
 - Less memory traffic, better fairness
- **Idea 3: Hardware turns coarse- into fine-grained locks!**
 - While also reducing memory traffic for lock in common case

Outline

- 1 RCU
- 2 Improving spinlock performance
- 3 Kernel interface for sleeping locks
- 4 Deadlock
- 5 Transactions
- 6 Scalable interface design

Read-copy update [McKenney]

- **Some data is read way more often than written**
 - Routing tables consulted for each forwarded packet
 - Data maps in system with 100+ disks (updated on disk failure)
- **Optimize for the common case of reading without lock**
 - Have global variable: `_Atomic(routing_table *) rt;`
 - Use it with no lock

```
#define RELAXED(var) \  
    atomic_load_explicit(&(var), memory_order_relaxed)  
  
/* ... */  
  
    route = lookup(RELAXED(rt), destination);
```

- **Update by making copy, swapping pointer**

```
/* update mutex held here, serializing updates */  
routing_table *newrt = copy_routing_table(rt);  
update_routing_table(newrt);  
atomic_store_explicit(&rt, newrt, memory_order_release);
```

Is RCU really safe?

- Consider the use of global `rt` with no fences:

```
lookup(RELAXED(rt), route);
```

- Could a CPU read new pointer but then old contents of `*rt`?
- Yes on alpha, No on all other existing architectures
- We are saved by *dependency ordering* in hardware
 - Instruction *B* depends on *A* if *B* uses result of *A*
 - Non-alpha CPUs won't re-order dependent instructions
 - If writer uses release fence, safe to load pointer then just use it
- This is the point of `memory_order_consume`
 - Should be equivalent to acquire barrier on alpha
 - But should compile to nothing (be free) on other machines
 - But hard to get semantics right (temporarily deprecated in C++)

Preemptible kernels

- **Recall *kernel process context* from [lecture 1](#)**
 - When CPU in kernel mode but executing on behalf of a process (e.g., might be in system call or page fault handler)
 - As opposed to interrupt handlers or context switch code
- **A *preemptible kernel* can preempt process context code**
 - Take a CPU core away from kernel process context code between any two instructions
 - Give the same CPU core to kernel code for a different process
- **Don't confuse with:**
 - Interrupt handlers can always preempt process context code
 - Preemptive threads (always have for multicore)
 - Process context code running concurrently on other CPU cores
- **Sometimes want or need to disable preemption**
 - Code that must not be migrated between CPUs (per-CPU structs)
 - Before acquiring spinlock (could improve performance)

Garbage collection

- **When can you free memory of old routing table?**
 - When you are guaranteed no one is using it—how to determine?
- **Definitions:**
 - *temporary variable* – short-used (e.g., local) variable
 - *permanent variable* – long lived data (e.g., global `rt` pointer)
 - *quiescent state* – when all a thread's temporary variables dead
 - *quiescent period* – time during which every thread has been in quiescent state at least once
- **Free old copy of updated data after quiescent period**
 - How to determine when quiescent period has gone by?
 - E.g., keep count of syscalls/context switches on each CPU
- **Restrictions:**
 - Can't hold a pointer across context switch or user mode (Never copy `rt` into another permanent variable)
 - Must disable preemption while consuming RCU data structure

Outline

- 1 RCU
- 2 Improving spinlock performance
- 3 Kernel interface for sleeping locks
- 4 Deadlock
- 5 Transactions
- 6 Scalable interface design

Useful macros

- **Atomic compare and swap:** CAS (mem, old, new)
 - If `*mem == old`, then swap `*mem↔new` and return `true`, else `false`
 - On x86, can implement using locked `cmpxchg` instruction
 - In C11, use `atomic_compare_exchange_strong`
(note: C atomics version sets `old = *mem` if `*mem != old`)
- **Atomic swap:** XCHG (mem, new)
 - Atomically exchanges `*mem↔new`
 - Implement w. C11 `atomic_exchange`, or `xchg` on x86
- **Atomic fetch and add:** FADD (mem, val)
 - Atomically sets `*mem += val` and returns *old* value of `*mem`
 - Implement w. C11 `atomic_fetch_add`, `lock add` on x86
- **Atomic fetch and subtract:** FSUB (mem, val)
- **Note: atomics return previous value (like `x++`, not `++x`)**
- **All behave like sequentially consistent fences**
 - In C11, weaker `_explicit` versions take a `memory_order` argument

MCS lock

- **Idea 2: Build a better spinlock**
- **Lock designed by Mellor-Crummey and Scott**
 - Goal: reduce bus traffic on cc machines, improve fairness
- **Each CPU has a `qnode` structure in local memory**

```
typedef struct qnode {
    _Atomic (struct qnode *) next;
    atomic_bool locked;
} qnode;
```

- Local can mean local memory in NUMA machine
 - Or just its own cache line that gets cached in exclusive mode
- **While waiting, spin on *your local* `locked` flag**
- **A lock is a `qnode` pointer:** `typedef _Atomic (qnode *) lock;`
 - Construct list of CPUs holding or waiting for lock
 - `lock` itself points to tail of list `list` (or `NULL` when unlocked)

MCS Acquire

- If unlocked, L is NULL
- If locked, no waiters, L is owner's qnode
- If waiters, *L is tail of waiter list:

```
acquire (lock *L, qnode *I) {  
    I->next = NULL;  
    qnode *predecessor = I;  
    XCHG (*L, predecessor);  
    if (predecessor != NULL) {  
        I->locked = true;  
        predecessor->next = I;  
        while (I->locked)  
            ;  
    }  
}
```

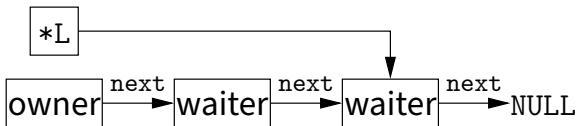

MCS Acquire

- If unlocked, L is NULL
- If locked, no waiters, L is owner's qnode
- If waiters, *L is tail of waiter list:

```
acquire (lock *L, qnode *I) {  
    I->next = NULL;  
    qnode *predecessor = I;  
    XCHG (*L, predecessor);  
    if (predecessor != NULL) {  
        I->locked = true;  
        predecessor->next = I;  
        while (I->locked)  
            ;  
    }  
}
```

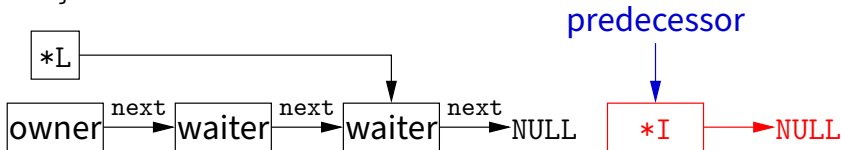

MCS Acquire

- If unlocked, L is NULL
- If locked, no waiters, L is owner's qnode
- If waiters, *L is tail of waiter list:

```
acquire (lock *L, qnode *I) {  
    I->next = NULL;  
    qnode *predecessor = I;  
    XCHG (*L, predecessor);  
    if (predecessor != NULL) {  
        I->locked = true;  
        predecessor->next = I;  
        while (I->locked)  
            ;  
    }  
}
```

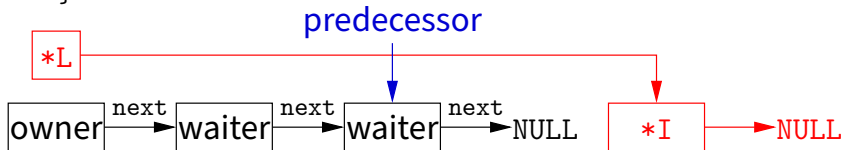

MCS Acquire

- If unlocked, L is NULL
- If locked, no waiters, L is owner's qnode
- If waiters, *L is tail of waiter list:

```
acquire (lock *L, qnode *I) {  
    I->next = NULL;  
    qnode *predecessor = I;  
    XCHG (*L, predecessor);  
    if (predecessor != NULL) {  
        I->locked = true;  
        predecessor->next = I;  
        while (I->locked)  
            ;  
    }  
}
```

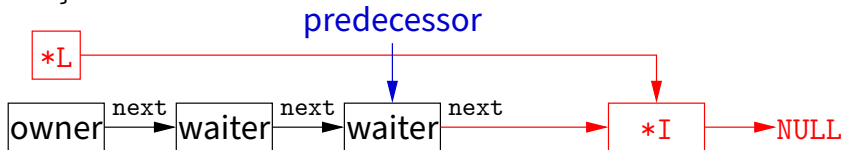

MCS Release with CAS

```
release (lock *L, qnode *I) {  
    if (!I->next)  
        if (CAS (*L, I, NULL))  
            return;  
    while (!I->next)  
        ;  
    I->next->locked = false;  
}
```

- **If** $I \rightarrow \text{next}$ **NULL** and $*L == I$
 - No one else is waiting for lock, OK to set $*L = \text{NULL}$

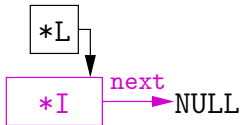

MCS Release with CAS

```
release (lock *L, qnode *I) {  
    if (!I->next)  
        if (CAS (*L, I, NULL))  
            return;  
    while (!I->next)  
        ;  
    I->next->locked = false;  
}
```

- **If** $I \rightarrow \text{next}$ **NULL** and $*L \neq I$
 - Another thread is in the middle of acquire
 - Just wait for $I \rightarrow \text{next}$ to be non-NULL

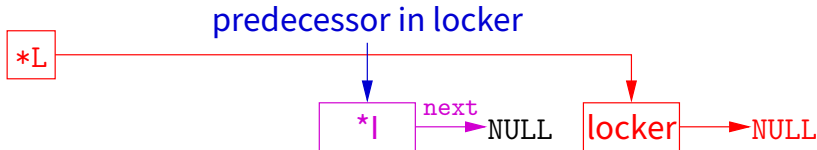

MCS Release with CAS

```
release (lock *L, qnode *I) {  
    if (!I->next)  
        if (CAS (*L, I, NULL))  
            return;  
    while (!I->next)  
        ;  
    I->next->locked = false;  
}
```

- **If I->next is non-NULL**

- I->next oldest waiter, wake up with I->next->locked = false

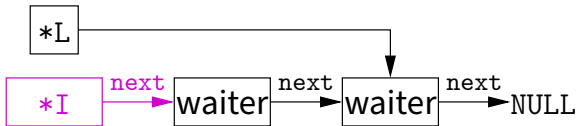

MCS Release w/o CAS

- **What to do if no atomic CAS (consensus number ∞), but do have XCHG (consensus number 2)?**
- **Be optimistic—read *L with two XCHGs:**
 - 1.** Atomically swap NULL into *L
 - If old value of *L was I, no waiters and we are done
 - 2.** Atomically swap old *L value back into *L
 - If *L unchanged, same effect as CAS
- **Otherwise, we have to clean up the mess**
 - Some “userper” attempted to acquire lock between **1** and **2**
 - Because *L was NULL, the userper succeeded (May be followed by zero or more waiters)
 - Graft old list of waiters on to end of new last waiter (Sacrifice small amount of fairness, but still safe)

MCS Release w/o C&S code

```
release (lock *L, qnode *I) {
    if (I->next)
        I->next->locked = false;
    else {
        qnode *old_tail = NULL;
        XCHG (*L, old_tail);
        if (old_tail == I)
            return;

        /* old_tail != I? CAS would have failed, so undo XCHG */
        qnode *userper = old_tail;
        XCHG (*L, userper);
        while (I->next == NULL)
            ;
        if (userper) /* someone changed *L between 2 XCHGs */
            userper->next = I->next;
        else
            I->next->locked = false;
    }
}
```

Outline

- 1 RCU
- 2 Improving spinlock performance
- 3 Kernel interface for sleeping locks
- 4 Deadlock
- 5 Transactions
- 6 Scalable interface design

Kernel support for sleeping locks

- **Sleeping locks must interact with scheduler**
 - For processes or kernel threads, must go into kernel (expensive)
 - Common case is you can acquire lock—how to optimize?
- **Idea: never enter kernel for uncontested lock**

```
struct lock {
    atomic_flag busy;
    _Atomic (thread *) waiters; /* wait-free stack/queue */
};
void acquire (lock *lk) {
    while (atomic_flag_test_and_set (&lk->busy)) { /* 1 */
        atomic_push (&lk->waiters, self);          /* 2 */
        sleep ();
    }
}
void release (lock *lk) {
    atomic_flag_clear(&lk->busy);
    wakeup (atomic_pop (&lk->waiters));
}
```

Race condition

- **Unfortunately, previous slide not safe**
 - What happens if release called between lines 1 and 2?
 - wakeup called on NULL, so acquire blocks
- ***futex* abstraction solves the problem [Franke]**
 - Ask kernel to sleep only if memory location hasn't changed
- `void futex (int *uaddr, FUTEX_WAIT, int val...);`
 - Go to sleep only if `*uaddr == val`
 - Extra arguments allow timeouts, etc.
- `void futex (int *uaddr, FUTEX_WAKE, int val...);`
 - Wake up at most `val` threads sleeping on `uaddr`
- `uaddr` **is translated down to offset in VM object**
 - So works on memory mapped file at different virtual addresses in different processes

Futex example

```
struct lock {
    atomic_flag busy;
};
void acquire (lock *lk) {
    while (atomic_flag_test_and_set (&lk->busy))
        futex(&lk->busy, FUTEX_WAIT, 1);
}
void release (lock *lk) {
    atomic_flag_clear (&lk->busy);
    futex(&lk->busy, FUTEX_WAKE, 1);
}
```

- **What's suboptimal about this code?**
- **See [\[Drepper\]](#) for these examples and a good discussion**

Futex example

```
struct lock {
    atomic_flag busy;
};
void acquire (lock *lk) {
    while (atomic_flag_test_and_set (&lk->busy))
        futex(&lk->busy, FUTEX_WAIT, 1);
}
void release (lock *lk) {
    atomic_flag_clear (&lk->busy);
    futex(&lk->busy, FUTEX_WAKE, 1);
}
```

- **What's suboptimal about this code?**
 - release requires a system call (expensive) even with no contention
- See [\[Drepper\]](#) for these examples and a good discussion

Futex example, second attempt

```
static_assert (ATOMIC_INT_LOCK_FREE >= 2);

struct lock {
    atomic_int busy;
};
void acquire (lock *lk) {
    int c;
    while ((c = FADD(&lk->busy, 1)))           /* 1 */
        futex((int*) &lk->busy, FUTEX_WAIT, c+1); /* 2 */
}
void release (lock *lk) {
    if (FSUB(&lk->busy, 1) != 1) {
        lk->busy = 0;
        futex((int*) &lk->busy, FUTEX_WAKE, 1);
    }
}
```

- Now what's wrong with this code?

Futex example, second attempt

```
static_assert (ATOMIC_INT_LOCK_FREE >= 2);

struct lock {
    atomic_int busy;
};

void acquire (lock *lk) {
    int c;
    while ((c = FADD(&lk->busy, 1)))          /* 1 */
        futex((int*) &lk->busy, FUTEX_WAIT, c+1); /* 2 */
}

void release (lock *lk) {
    if (FSUB(&lk->busy, 1) != 1) {
        lk->busy = 0;
        futex((int*) &lk->busy, FUTEX_WAKE, 1);
    }
}
```

- **Now what's wrong with this code?**

- Two threads could interleave lines 1 and 2, never sleep
- Could even overflow the counter, violate mutual exclusion

Futex example, third attempt

```
struct lock {
    // 0=unlocked, 1=locked no waiters, 2=locked+waiters
    atomic_int state;
};

void acquire (lock *lk) {
    int c = 1;
    if (!CAS (&lk->state, 0, c)) {
        XCHG (&lk->state, c = 2);
        while (c != 0) {
            futex ((int *) &lk->state, FUTEX_WAIT, 2);
            XCHG (&lk->state, c = 2);
        }
    }
}

void release (lock *lk) {
    if (FSUB (&lk->state, 1) != 1) { // FSUB returns old value
        lk->state = 0;
        futex ((int *) &lk->state, FUTEX_WAKE, 1);
    }
}
```

Outline

- 1 RCU
- 2 Improving spinlock performance
- 3 Kernel interface for sleeping locks
- 4 **Deadlock**
- 5 Transactions
- 6 Scalable interface design

The deadlock problem

```
mutex_t m1, m2;

void p1 (void *ignored) {
    lock (m1);
    lock (m2);
    /* critical section */
    unlock (m2);
    unlock (m1);
}

void p2 (void *ignored) {
    lock (m2);
    lock (m1);
    /* critical section */
    unlock (m1);
    unlock (m2);
}
```

- This program can cease to make progress – how?
- Can you have deadlock w/o mutexes?

More deadlocks

- **Same problem with condition variables**
 - Suppose resource 1 managed by c_1 , resource 2 by c_2
 - A has 1, waits on c_2 , B has 2, waits on c_1
- **Or have combined mutex/condition variable deadlock:**
 - `lock (a); lock (b); while (!ready) wait (b, c);
unlock (b); unlock (a);`
 - `lock (a); lock (b); ready = true; signal (c);
unlock (b); unlock (a);`
- **One lesson: Dangerous to hold locks when crossing abstraction barriers!**
 - I.e., `lock (a)` then call function that uses condition variable

Deadlocks w/o computers

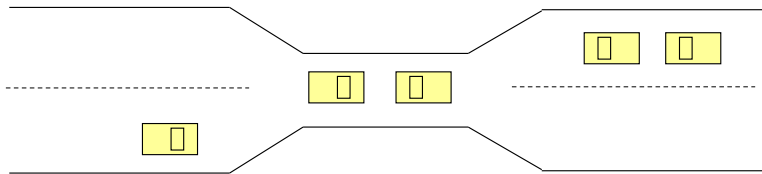

- **Real issue is *resources* & how required**
- **E.g., bridge only allows traffic in one direction**
 - Each section of a bridge can be viewed as a resource.
 - If a deadlock occurs, it can be resolved if one car backs up (preempt resources and rollback).
 - Several cars may have to be backed up if a deadlock occurs.
 - Starvation is possible.

Deadlock conditions

- 1. Limited access (mutual exclusion):**
 - Resource can only be shared with finite users
- 2. No preemption:**
 - Once resource granted, cannot be taken away
- 3. Multiple independent requests (hold and wait):**
 - Don't ask all at once
(wait for next resource while holding current one)
- 4. Circularity in graph of requests**
 - All of 1–4 necessary for deadlock to occur
 - Two approaches to dealing with deadlock:
 - Pro-active: prevention
 - Reactive: detection + corrective action

Prevent by eliminating one condition

1. Limited access (mutual exclusion):

- Buy more resources, split into pieces, or virtualize to make "infinite" copies
- Threads: threads have copy of registers = no lock

2. No preemption:

- Physical memory: virtualized with VM, can take physical page away and give to another process!

3. Multiple independent requests (hold and wait):

- Wait on all resources at once (must know in advance)

4. Circularity in graph of requests

- Single lock for entire system: (problems?)
- Partial ordering of resources (next)

Resource-allocation graph

- **View system as graph**

- Processes and Resources are nodes
- Resource Requests and Assignments are edges

- **Process:** 

- **Resource with 4 instances:** 

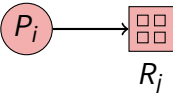
- P_i requesting R_j : 

- P_i holding instance of R_j : 

Example resource allocation graph

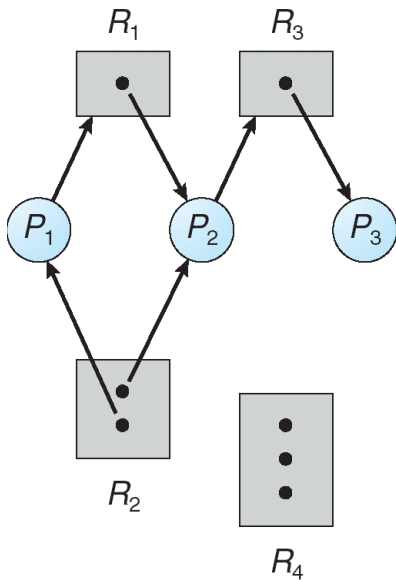

Graph with deadlock

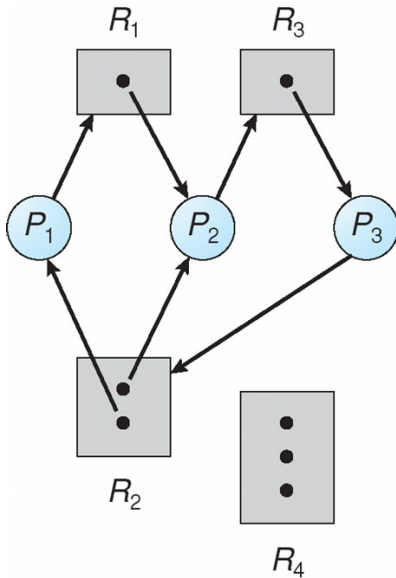

Is this deadlock?

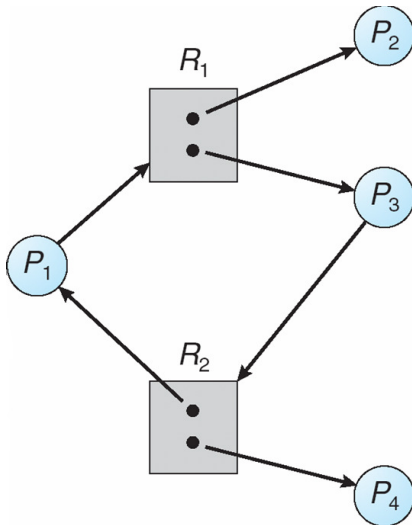

Cycles and deadlock

- **If graph has no cycles \implies no deadlock**
- **If graph contains a cycle**
 - Definitely deadlock if only one instance per resource
 - Otherwise, maybe deadlock, maybe not
- **Prevent deadlock with partial order on resources**
 - E.g., always acquire mutex m_1 before m_2
 - Usually design locking discipline for application this way

Prevention

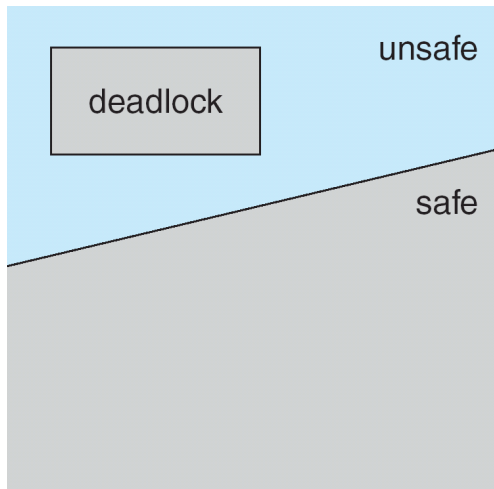

- Determine safe states based on *possible* resource allocation
- Conservatively prohibits non-deadlocked states

Claim edges

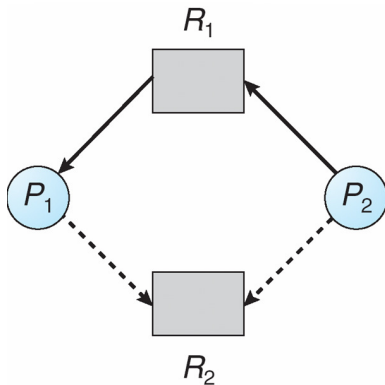

- **Dotted line is *claim edge***
 - Signifies process *may* request resource

Example: unsafe state

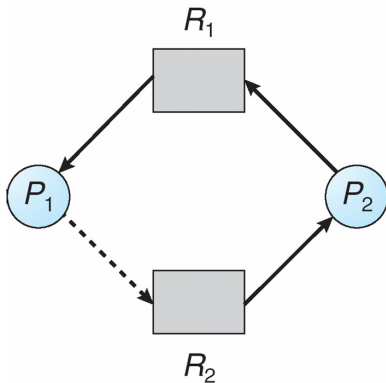

- **Note cycle in graph**

- P_1 might request R_2 before relinquishing R_1
- Would cause deadlock

Detecting deadlock

- Static approaches (hard)
- Dynamically, program grinds to a halt
 - Threads package can diagnose by keeping track of locks held:

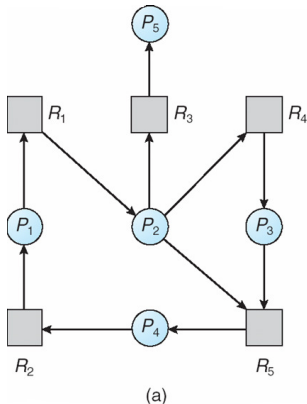

Resource-Allocation Graph

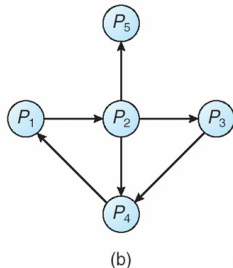

Corresponding wait-for graph

Fixing & debugging deadlocks

- **Reboot system / restart application**
- **Examine hung process with debugger**
- **Threads package can deduce partial order**
 - For each lock acquired, order with other locks held
 - If cycle occurs, abort with error
 - Detects *potential* deadlocks even if they do not occur
- **Or use *transactions*...**
 - Another paradigm for handling concurrency
 - Often provided by databases, but some OSes use them
 - *Vino* OS used transactions to abort after failures [[Seltzer](#)]

Outline

- 1 RCU
- 2 Improving spinlock performance
- 3 Kernel interface for sleeping locks
- 4 Deadlock
- 5 Transactions
- 6 Scalable interface design

Transactions

- **A transaction T is a collection of actions with**
 - *Atomicity* – all or none of actions happen
 - *Consistency* – T leaves data in valid state
 - *Isolation* – T 's actions all appear to happen before or after every other transaction
 - *Durability*¹ – T 's effects will survive reboots
 - Often hear mnemonic *ACID* to refer to above
- **Transactions typically executed concurrently**
 - But *isolation* means must *appear* not to
 - Must roll-back transactions that use others' state
 - Means you have to record all changes to undo them
- **When deadlock detected just abort a transaction**
 - Breaks the dependency cycle

¹Not applicable to topics in this lecture

Transactional memory

- **Some modern processors support *transactional memory***
- **Transactional Synchronization Extensions (TSX) [intel1§16]**
 - `xbegin abort_handler` – begins a transaction
 - `xend` – commit a transaction
 - `xabort $code` – abort transaction with 8-bit code
 - Note: nested transactions okay (also `xtest` tests if in transaction)
- **During transaction, processor tracks accessed memory**
 - Keeps read-set and write-set of cache lines
 - Nothing gets written back to memory during transaction
 - Transaction aborts (at `xend` or earlier) if any conflicts
 - Otherwise, all dirty cache lines are “written” atomically (in practice switch to non-transactional M state of MESI)

Using transactional memory

- **Idea 3: Use to get “free” fine-grained locking on a hash table**
 - E.g., concurrent inserts that don't touch same buckets are okay
 - Should *read* spinlock to make sure not taken (but not write) [Kim]
 - Hardware will detect there was no conflict
- **Can also use to poll for one of many asynchronous events**
 - Start transaction
 - Fill cache with values to which you want to see changes
 - Loop until a write causes your transaction to abort
- **Note: Transactions are never guaranteed to commit**
 - Might overflow cache, get false sharing, see weird processor issue
 - Means abort path must always be able to perform transaction (e.g., you do need a lock on your hash table)

Hardware lock elision (HLE)

- **Idea: make it so spinlocks rarely need to spin**
 - Begin a transaction when you acquire lock
 - Other CPUs won't see lock acquired, can also enter critical section
 - Okay not to have mutual exclusion when no memory conflicts!
 - On conflict, abort and restart without transaction, thereby visibly acquiring lock (and aborting other concurrent transactions)
- **Intel support:**
 - Use `xacquire` prefix before `xchgl` (used for test and set)
 - Use `xrelease` prefix before `movl` that releases lock
 - Prefixes chosen to be noops on older CPUs (binary compatibility)
- **Hash table example:**
 - Use `xacquire xchgl` in table-wide test-and-set spinlock
 - Works correctly on older CPUs (with coarse-grained lock)
 - Allows safe concurrent accesses on newer CPUs!

Outline

- 1 RCU
- 2 Improving spinlock performance
- 3 Kernel interface for sleeping locks
- 4 Deadlock
- 5 Transactions
- 6 Scalable interface design

Scalable interfaces

- Not all interfaces can scale
- How to tell which can and which can't?
- Scalable Commutativity Rule: *“Whenever interface operations commute, they can be implemented in a way that scales”*
[Clements]

Are fork(), execve() broadly commutative?

```
pid_t pid = fork();  
if (!pid)  
    execlp("bash", "bash", NULL);
```

Are fork(), execve() broadly commutative?

```
pid_t pid = fork();  
if (!pid)  
    execlp("bash", "bash", NULL);
```

- **No, fork() doesn't commute with memory writes, many file descriptor operations, and all address space operations**
 - E.g., close(fd); fork(); vs. fork(); close(fd);
- **execve() often follows fork() and undoes most of fork()'s sub operations**
- **posix_spawn(), which combines fork() and execve() into a single operation, is broadly commutative**
 - But obviously more complex, less flexible
 - Maybe Microsoft will have the last laugh?

Is open() broadly commutative?

```
int fd1 = open("foo", O_RDONLY);  
int fd2 = open("bar", O_RDONLY);
```

Is open() broadly commutative?

```
int fd1 = open("foo", O_RDONLY);  
int fd2 = open("bar", O_RDONLY);
```

- **Actually `open()` does not broadly commute!**
- **Does not commute with any system call (including itself) that creates a file descriptor**
- **Why? POSIX requires new descriptors to be assigned the lowest available integer**
- **If we fixed this, `open()` would commute, as long as it is not creating a file in the same directory as another operation**