

# Administrivia

- **Two new CAs: June Lee and Alice Liu**
  - More office hours
- **My office hours moved to 4pm today**
- **Lab 1 due Wednesday 1:30pm (5pm if you attend lecture)**
- **We give will give short extensions to groups that run into trouble. But email us:**
  - How much is done and left?
  - How much longer do you need?
- **Attend section Friday at 1:30pm to learn about lab 2**

# Virtual memory

- Came out of work in late 1960s by **Peter Denning** (lower right)
  - Established working set model
  - Led directly to virtual memory



# Want processes to co-exist

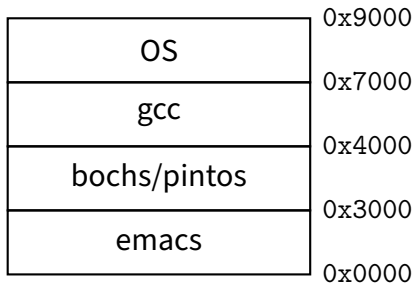

- **Consider multiprogramming on physical memory**
  - What happens if pintos needs to expand?
  - If emacs needs more memory than is on the machine?
  - If pintos has an error and writes to address 0x7100?
  - When does gcc have to know it will run at 0x4000?
  - What if emacs isn't using its memory?

# Issues in sharing physical memory

- **Protection**

- A bug in one process can corrupt memory in another
- Must somehow prevent process *A* from trashing *B*'s memory
- Also prevent *A* from even observing *B*'s memory (ssh-agent)

- **Transparency**

- A process shouldn't require particular physical memory bits
- Yet processes often require large amounts of contiguous memory (for stack, large data structures, etc.)

- **Resource exhaustion**

- Programmers typically assume machine has "enough" memory
- Sum of sizes of all processes often greater than physical memory

# Virtual memory goals

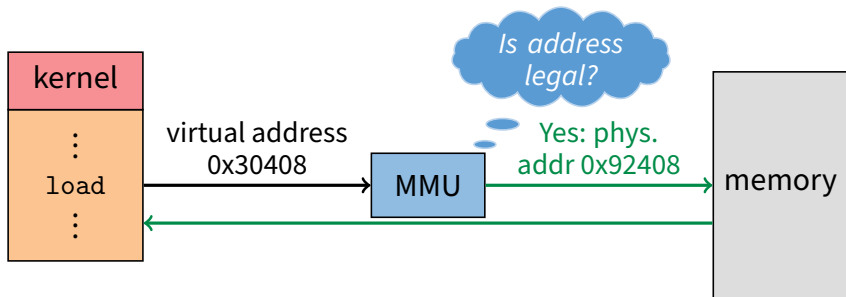

- **Give each program its own *virtual* address space**
  - At runtime, *Memory-Management Unit* relocates each load/store
  - Application doesn't see *physical* memory addresses
- **Also enforce protection**
  - Prevent one app from messing with another's memory
- **And allow programs to see more memory than exists**
  - Somehow relocate some memory accesses to disk

# Virtual memory goals

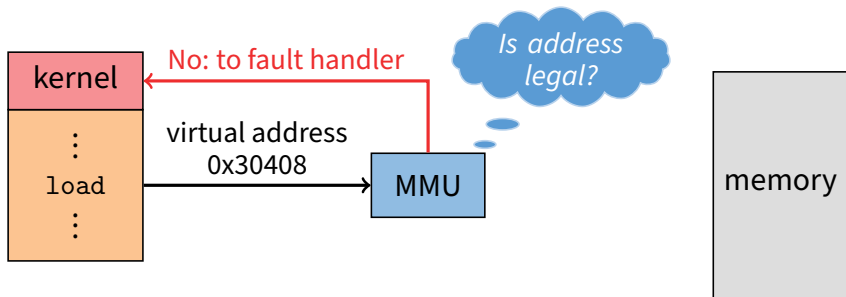

- **Give each program its own *virtual* address space**
  - At runtime, *Memory-Management Unit* relocates each load/store
  - Application doesn't see *physical* memory addresses
- **Also enforce protection**
  - Prevent one app from messing with another's memory
- **And allow programs to see more memory than exists**
  - Somehow relocate some memory accesses to disk

# Virtual memory advantages

- **Can re-locate program while running**
  - Run partially in memory, partially on disk
- **Most of a process's memory may be idle (80/20 rule).**

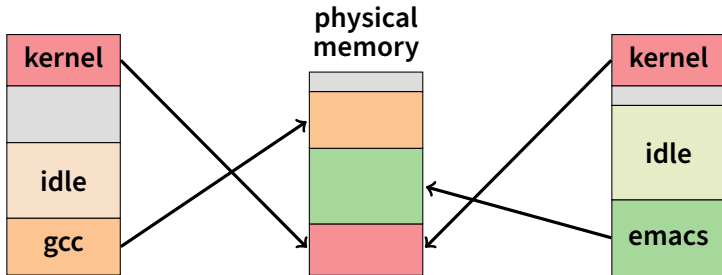

- Write idle parts to disk until needed
  - Let other processes use memory of idle part
  - Like CPU virtualization: when process not using CPU, switch (Not using a memory region? switch it to another process)
- **Challenge: VM = extra layer, could be slow**

# Idea 1: no hardware, load-time linking

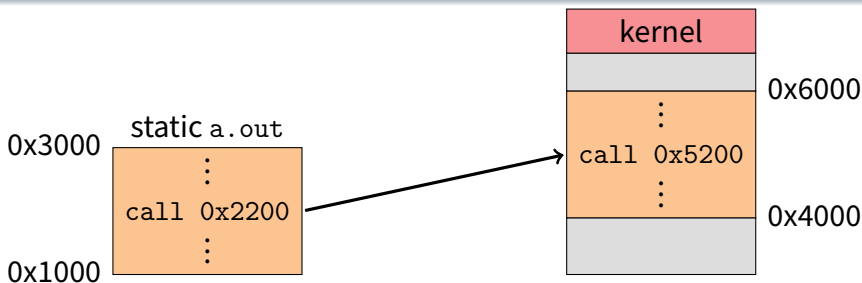

- **Linker patches addresses of symbols like `printf`**
- **Idea: link when process executed, not at compile time**
  - Already have PIE (position-independent executable) for security
  - Determine where process will reside in memory at launch
  - Adjust all references within program (using addition)
- **Problems?**

# Idea 1: no hardware, load-time linking

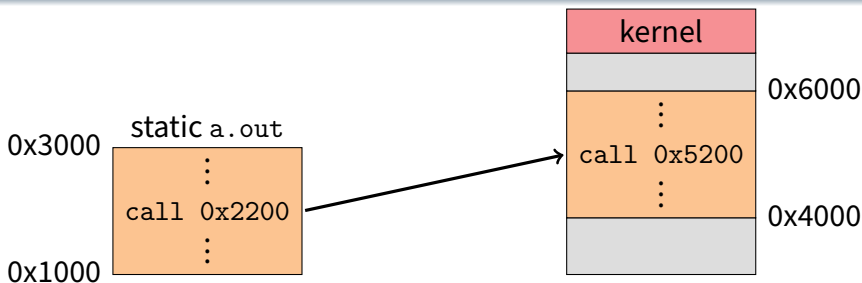

- **Linker patches addresses of symbols like `printf`**
- **Idea: link when process executed, not at compile time**
  - Already have PIE (position-independent executable) for security
  - Determine where process will reside in memory at launch
  - Adjust all references within program (using addition)
- **Problems?**
  - How to enforce protection?
  - How to move once already in memory? (consider data pointers)
  - What if no contiguous free region fits program?

## Idea 2: base + bound register

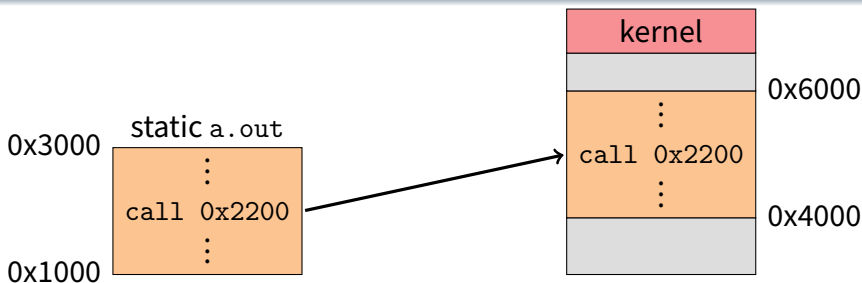

- Two special privileged registers: **base** and **bound**
- On each load/store/jump:
  - Physical address = virtual address + **base**
  - Check  $0 \leq \text{virtual address} < \text{bound}$ , else trap to kernel
- How to move process in memory?
- What happens on context switch?

## Idea 2: base + bound register

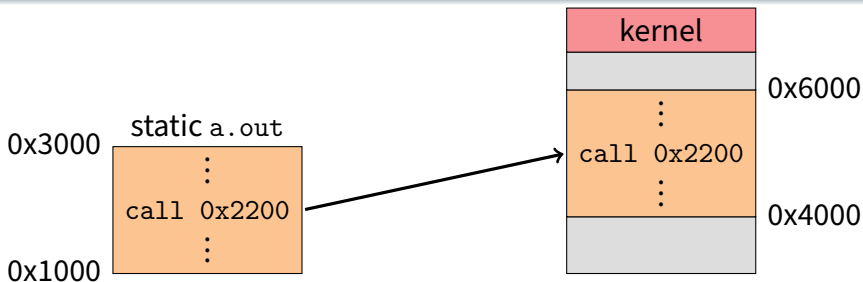

- Two special privileged registers: **base** and **bound**
- On each load/store/jump:
  - Physical address = virtual address + **base**
  - Check  $0 \leq \text{virtual address} < \text{bound}$ , else trap to kernel
- How to move process in memory?
  - Change **base** register
- What happens on context switch?

## Idea 2: base + bound register

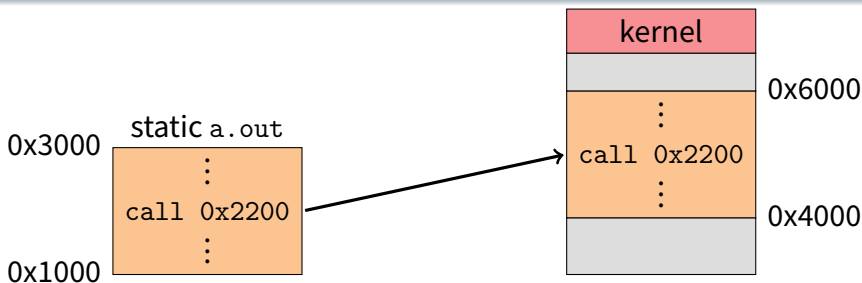

- Two special privileged registers: **base** and **bound**
- On each load/store/jump:
  - Physical address = virtual address + **base**
  - Check  $0 \leq \text{virtual address} < \text{bound}$ , else trap to kernel
- How to move process in memory?
  - Change **base** register
- What happens on context switch?
  - Kernel must re-load **base** and **bound** registers

# Definitions

- Programs load/store to **virtual addresses**
- Actual memory uses **physical addresses**
- VM Hardware is Memory Management Unit (**MMU**)

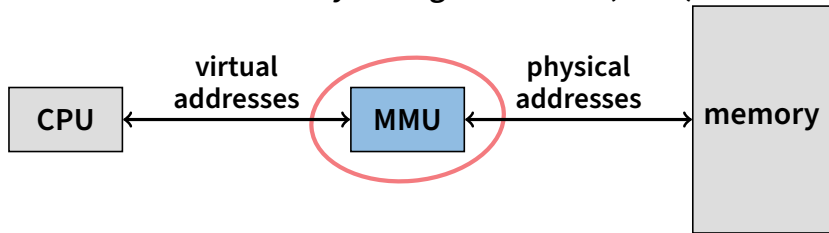

- Usually part of CPU core (one address space per hyperthread)
- Configured through privileged instructions (e.g., load bound reg)
- Translates from virtual to physical addresses
- Gives per-process view of memory called **address space**

# Definitions

- Programs load/store to **virtual addresses**
- Actual memory uses **physical addresses**
- VM Hardware is Memory Management Unit (**MMU**)

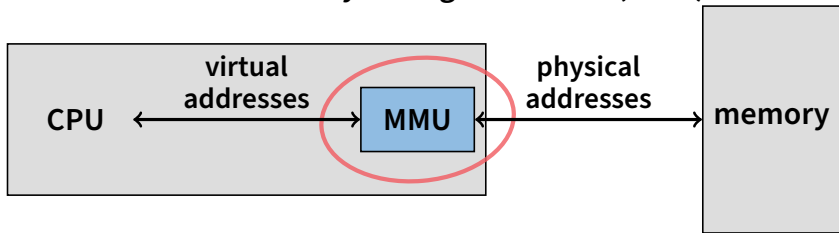

- Usually part of CPU core (one address space per hyperthread)
- Configured through privileged instructions (e.g., load bound reg)
- Translates from virtual to physical addresses
- Gives per-process view of memory called **address space**

# Base+bound trade-offs

- **Advantages**

- Cheap in terms of hardware: only two registers
- Cheap in terms of cycles: do add and compare in parallel
- Examples: Cray-1 used this scheme

- **Disadvantages**

# Base+bound trade-offs

- **Advantages**

- Cheap in terms of hardware: only two registers
- Cheap in terms of cycles: do add and compare in parallel
- Examples: Cray-1 used this scheme

- **Disadvantages**

- Growing a process is expensive or impossible
- No way to share code or data (E.g., two copies of bochs, both running pintos)

- **One solution: Multiple segments**

- E.g., separate code, stack, data segments
- Possibly multiple data segments

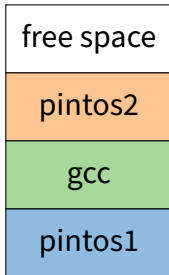

# Segmentation

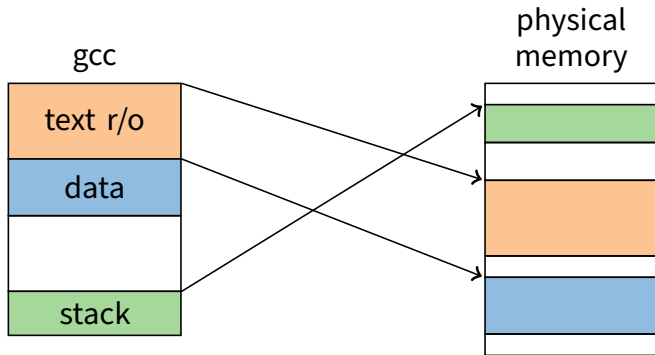

- **Let processes have many base/bound regs**
  - Address space built from many segments
  - Can share/protect memory at segment granularity
- **Must specify segment as part of virtual address**

# Segmentation mechanics

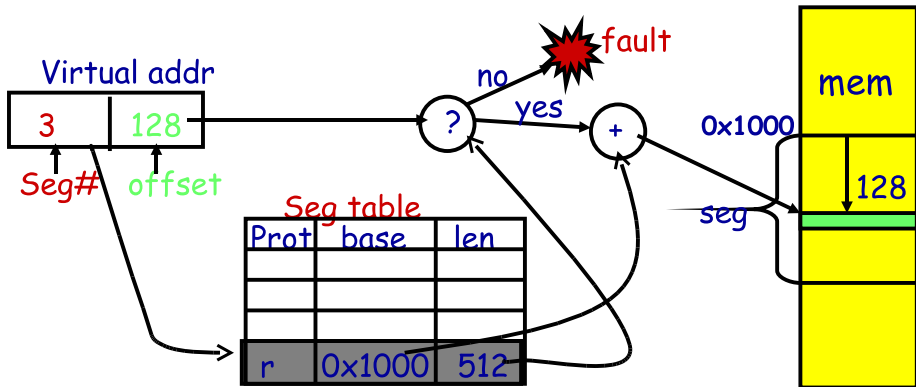

- Each process has a segment table
- Each VA indicates a segment and offset:
  - Top bits of addr select segment, low bits select offset (PDP-10)
  - Or segment selected by instruction or operand (means you need wider “far” pointers to specify segment)

# Segmentation example

Seg	base	bounds	rw
0	0x4000	0x6ff	10
1	0x0000	0x4ff	11
2	0x3000	0xfff	11
3			00

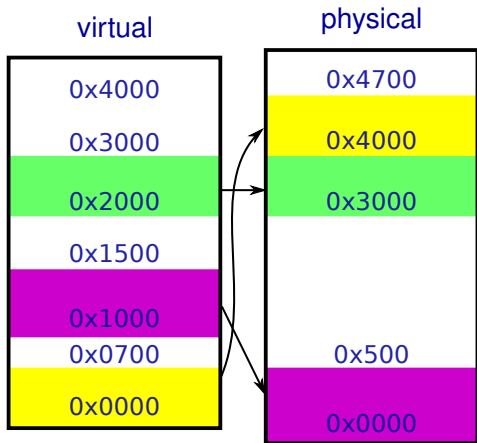

- **2-bit segment number (1st digit), 12 bit offset (last 3)**
  - Where is 0x0240? 0x1108? 0x265c? 0x3002? 0x1600?

# Segmentation trade-offs

- **Advantages**

- Multiple segments per process
- Allows sharing! (how?)
- Don't need entire process in memory

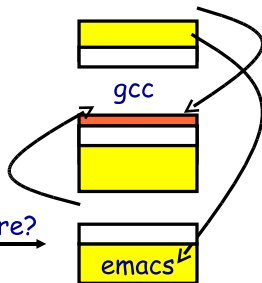

- **Disadvantages**

- Requires translation hardware, which could limit performance
- Segments not completely transparent to program (e.g., default segment faster or uses shorter instruction)
- $n$  byte segment needs  $n$  contiguous bytes of physical memory
- Makes *fragmentation* a real problem.

# Fragmentation

- **Fragmentation**  $\implies$  Inability to use free memory
- **Over time:**
  - Variable-sized pieces = many small holes (external fragmentation)
  - Fixed-sized pieces = no external holes, but force internal waste (internal fragmentation)

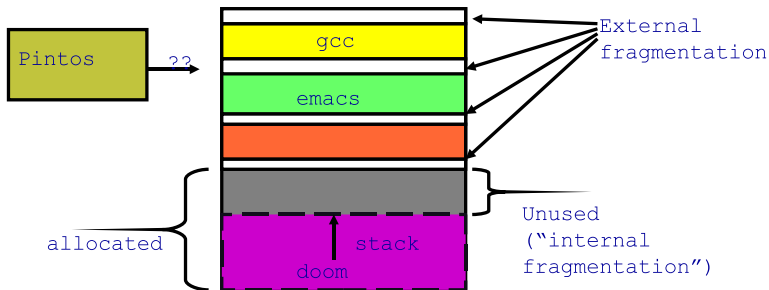

# Alternatives to hardware MMU

- **Language-level protection (JavaScript)**
  - Single address space for different modules
  - Language enforces isolation
  - Singularity OS does this with C# [Hunt]
- **Software fault isolation**
  - Instrument compiler output
  - Checks before every store operation prevents modules from trashing each other
  - Google's now deprecated [Native Client](#) does this for x86 [Yee]
  - Easier to do for virtual architecture, e.g., [Wasm](#)
  - Works really well on ARM64 [Yedidia'24]

# Paging

- **Divide memory up into small, equal-size *pages***
- **Map virtual pages to physical pages**
  - Each process has separate mapping
- **Allow OS to gain control on certain operations**
  - Read-only pages trap to OS on write
  - Invalid pages trap to OS on read or write
  - OS can change mapping and resume application
- **Other features sometimes found:**
  - Hardware can set “accessed” and “dirty” bits
  - Control page execute permission separately from read/write
  - Control caching or memory consistency of page

# Paging trade-offs

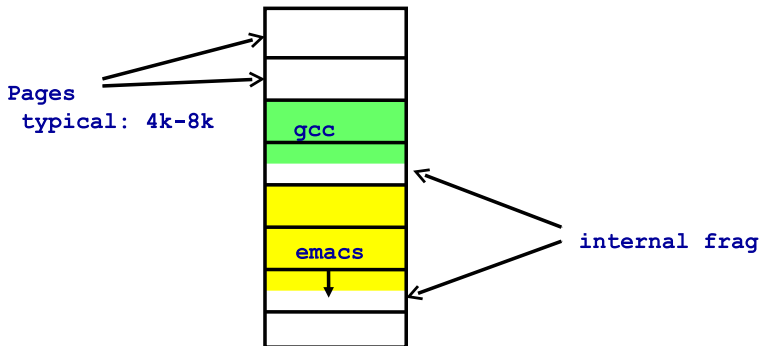

- Eliminates external fragmentation
- Simplifies allocation, free, and backing storage (swap)
- Average internal fragmentation of .5 pages per “segment”

# Simplified allocation

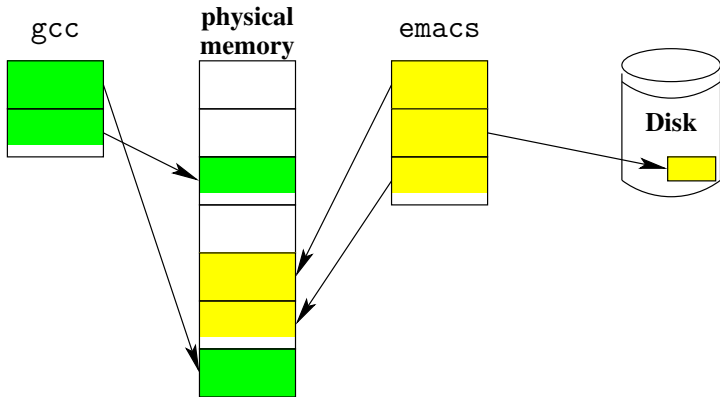

- Allocate any physical page to any process
- Can store idle virtual pages on disk

# Paging data structures

- Pages are fixed size, e.g., 4 KiB
  - Least significant 12 ( $\log_2 4 \text{ Ki}$ ) bits of address are *page offset*
  - Most significant bits are *page number*
- Each process has a *page table*
  - Maps *virtual page numbers* (VPNs) to *physical page numbers* (PPNs)
  - Also includes bits for protection, validity, etc.
- On memory access: Translate VPN to PPN, then add offset

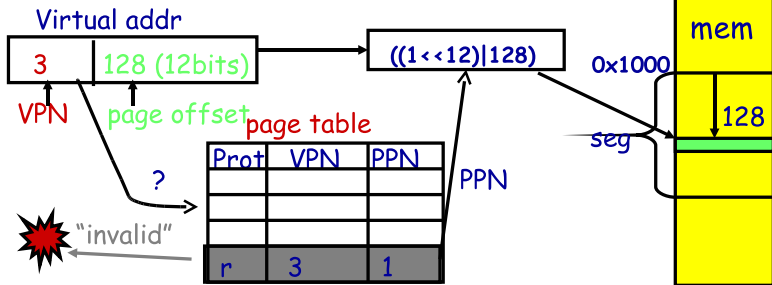

# Example: Paging on PDP-11

- **64 KiB virtual memory, 8 KiB pages**
  - Separate address space for instructions & data
  - I.e., can't read your own instructions with a load
- **Entire page table stored in registers**
  - 8 Instruction page translation registers
  - 8 Data page translations
- **Swap 16 machine registers on each context switch**

# x86 Paging

- **Paging enabled by bits in a control register (%cr0)**
  - Only privileged OS code can manipulate control registers
- **Normally 4 KiB pages**
- **%cr3: points to physical address of 4 KiB page directory**
  - See [pagedir\\_activate](#) in Pintos
- **Page directory: 1024 PDEs (page directory entries)**
  - Each contains physical address of a page table
- **Page table: 1024 PTEs (page table entries)**
  - Each contains physical address of virtual 4K page
  - Page table covers 4 MiB of Virtual mem
- **See [old intel manual](#) for simplest explanation**
  - Also volume 2 of [AMD64 Architecture docs](#)
  - Also volume 3A of [latest intel 64 architecture manual](#)

# x86 page translation

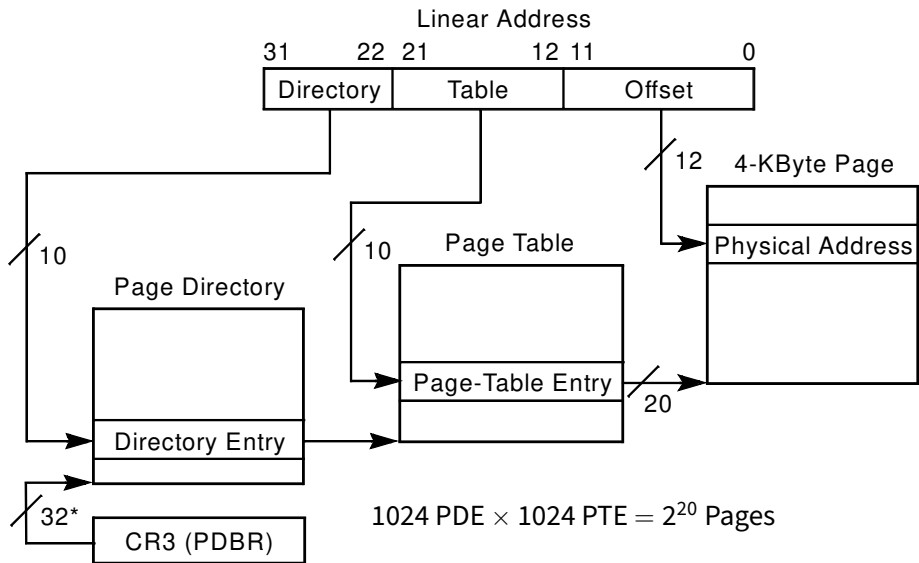

\*32 bits aligned onto a 4-KByte boundary





# x86 hardware segmentation

- **x86 architecture *also* supports segmentation**
  - Segment register base + pointer val = *linear address*
  - Page translation happens on linear addresses
- **Two levels of protection and translation check**
  - Segmentation model has four privilege levels (CPL 0–3)
  - Paging only two, so 0–2 = kernel, 3 = user
- **Why do you want *both* paging and segmentation?**

# x86 hardware segmentation

- **x86 architecture *also* supports segmentation**
  - Segment register base + pointer val = *linear address*
  - Page translation happens on linear addresses
- **Two levels of protection and translation check**
  - Segmentation model has four privilege levels (CPL 0–3)
  - Paging only two, so 0–2 = kernel, 3 = user
- **Why do you want *both* paging and segmentation?**
- **Short answer: You don't – just adds overhead**
  - Most OSes use “flat mode” – set base = 0, bounds = 0xffffffff in all segment registers, then forget about it
  - x86-64 architecture removes much segmentation support
- **Long answer: Has some fringe/incidental uses**
  - Keep pointer to thread-local storage w/o wasting normal register
  - 32-bit VMware runs guest OS in CPL 1 to trap stack faults
  - OpenBSD used CS limit for W^X when no PTE NX bit

# Making paging fast

- **x86 PTs require 3 memory references per load/store**
  - Look up page table address in page directory
  - Look up physical page number (PPN) in page table
  - Actually access physical page corresponding to virtual address
- **For speed, CPU caches recently used translations**
  - Called a *translation lookaside buffer* or **TLB**
  - Typical: 64-2k entries, 4-way to fully associative, 95% hit rate
  - Modern CPUs add second-level TLB with  $\sim 1,024+$  entries; often separate instruction and data TLBs
  - Each TLB entry maps a VPN  $\rightarrow$  PPN + protection information
- **On each memory reference**
  - Check TLB, if entry present get physical address fast
  - If not, walk page tables, insert in TLB for next time (Must evict some entry)

# TLB details

- **TLB operates at CPU pipeline speed  $\implies$  small, fast**
- **Complication: what to do when switching address space?**
  - Flush TLB on context switch (e.g., old x86)
  - Tag each entry with associated process's ID (e.g., MIPS)
- **In general, OS must manually keep TLB valid**
  - Changing page table in memory won't affect cached TLB entry
- **E.g., on x86 must use *invlpg* instruction**
  - Invalidates a page translation in TLB
  - Note: very expensive instruction (100–200 cycles)
  - Must execute after changing a possibly used page table entry
  - Otherwise, hardware will miss page table change
- **More Complex on a multiprocessor (TLB shutdown)**
  - Requires sending an interprocessor interrupt (IPI)
  - Remote processor must execute *invlpg* instruction

# x86 Paging Extensions

- **PSE: Page size extensions**

- Setting bit 7 in PDE makes a 4 MiB translation (no PT)

- **PAE Page address extensions**

- Newer 64-bit PTE format allows 36+ bits of physical address
- Page tables, directories have only 512 entries
- Use 4-entry Page-Directory-Pointer Table to regain 2 lost bits
- PDE bit 7 allows 2 MiB translation

- **Long mode PAE (x86-64)**

- In Long mode, pointers are 64-bits
- Extends PAE to map 48 bits of virtual address (next slide)
- Why aren't all 64 bits of VA usable?

# x86 long mode paging

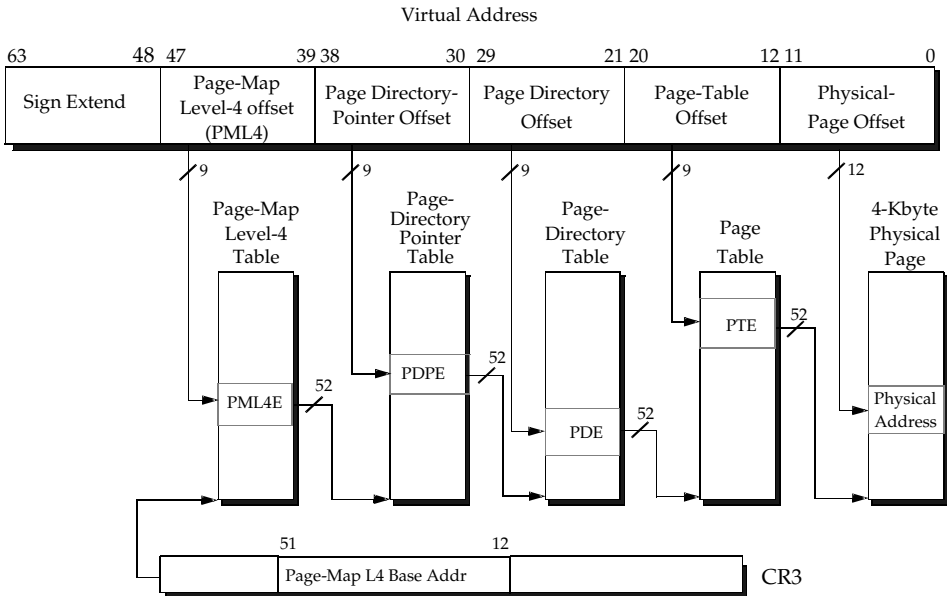

# Where does the OS live?

- **In its own address space?**
  - Can't do this on most hardware (e.g., syscall instruction won't switch address spaces)
  - Also would make it harder to parse syscall arguments passed as pointers
- **So in the same address space as process**
  - Use protection bits to prohibit user code from writing kernel
- **Typically all kernel text, most data at same VA in every address space**
  - On x86, must manually set up page tables for this
  - Usually just map kernel in contiguous virtual memory when boot loader puts kernel into contiguous physical memory
  - Some hardware puts physical memory (kernel-only) somewhere in virtual address space
  - Typically kernel goes in high memory; with signed numbers, can mean small negative addresses (small linker relocations)

# Pintos memory layout

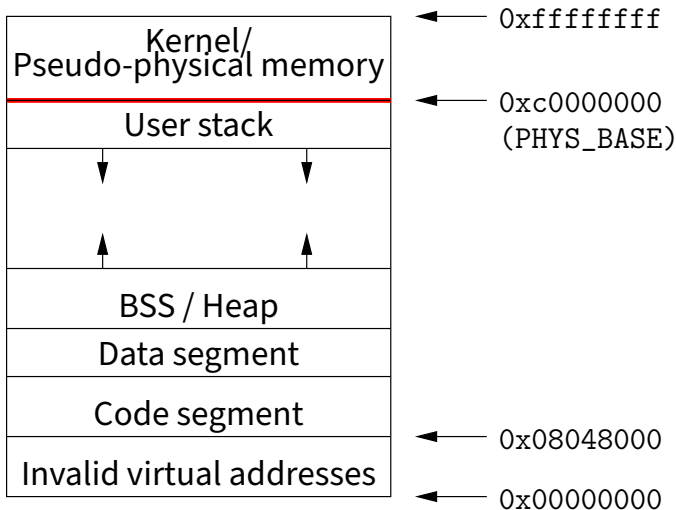

# Very different MMU: MIPS

- **Hardware checks TLB on application load/store**
  - References to addresses not in TLB trap to kernel
- **Each TLB entry has the following fields:  
Virtual page, Pid, Page frame, NC, D, V, Global**
- **Kernel itself unpaged**
  - All of physical memory contiguously mapped in high VM (hardwired in CPU, not just by convention as with Pintos)
  - Kernel uses these pseudo-physical addresses
- **User TLB fault handler very efficient**
  - Two hardware registers reserved for it
  - utlb miss handler can itself fault—allow paged page tables
- **OS is free to choose page table format!**

# DEC Alpha MMU

- **Firmware managed TLB**
  - Like MIPS, TLB misses handled by software
  - Unlike MIPS, TLB miss routines ship with machine in ROM (but copied to main memory on boot—so can be overwritten)
  - Firmware known as “PAL code” (privileged architecture library)
- **Hardware capabilities**
  - 8 KiB, 64 KiB, 512 KiB, 4 MiB pages all available
  - TLB supports 128 instruction/128 data entries of any size
- **Various other events vector directly to PAL code**
  - `call_pal` instruction, TLB miss/fault, FP disabled
- **PAL code runs in special privileged processor mode**
  - Interrupts always disabled
  - Have access to special instructions and registers

- **Examples of Digital Unix PALcode entry functions**
  - `callsys/retsys` - make, return from system call
  - `swpctx` - change address spaces
  - `wrvptptr` - write virtual page table pointer
  - `tbi` - TLB invalidate
- **Some fields in PALcode page table entries**
  - GH - 2-bit granularity hint  $\rightarrow 2^N$  pages have same translation
  - ASM - address space match  $\rightarrow$  mapping applies in all processes

# Example: Paging to disk

- `gcc` needs a new page of memory
- OS re-claims an idle page from `emacs`
- If page is *clean* (i.e., also stored on disk):
  - E.g., page of text from `emacs` binary on disk
  - Can always re-read same page from binary
  - So okay to discard contents now & give page to `gcc`
- If page is *dirty* (meaning memory is only copy)
  - Must write page to disk first before giving to `gcc`
- Either way:
  - Mark page invalid in `emacs`
  - `emacs` will fault on next access to virtual page
  - On fault, OS reads page data back from disk into new page, maps new page into `emacs`, resumes executing

# Paging in day-to-day use

- Demand paging
- Growing the stack
- BSS page allocation
- Shared text
- Shared libraries
- Shared memory
- Copy-on-write (`fork`, `mmap`, etc.)
- Q: Which pages should have global bit set on x86?