

Outline

- 1 FFS in more detail
- 2 Crash recovery
- 3 Soft updates
- 4 Journaling
- 5 F2FS

1 / 42

Review: FFS disk layout

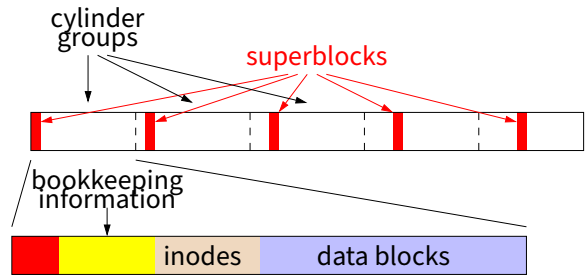

- Each cylinder group has its own:
 - Superblock
 - Bookkeeping information
 - Set of inodes
 - Data/directory blocks

2 / 42

Superblock

- Contains file system parameters
 - Disk characteristics, block size, CG info
 - Information necessary to locate inode given i-number
- Replicated once per cylinder group
 - At shifting offsets, so as to span multiple platters
 - Contains magic number `0x011954` to find replicas if 1st superblock dies (Kirk McKusick's birthday?)
- Contains non-replicated "summary information"
 - # blocks, fragments, inodes, directories in FS
 - Flag stating if FS was cleanly unmounted

3 / 42

Bookkeeping information

- Block map
 - Bit map of available fragments
 - Used for allocating new blocks/fragments
- Summary info within CG
 - # free inodes, blocks/frags, files, directories
 - Used when picking cylinder group from which to allocate
- # free blocks by rotational position (8 positions)
 - Was reasonable in 1980s when disks weren't commonly zoned
 - Back then OS could do stuff to minimize rotational delay

4 / 42

Inodes and data blocks

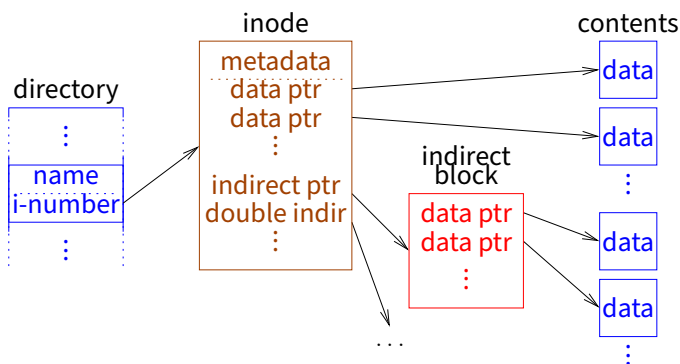

- Each CG has fixed # of inodes (default one per 2K data)
 - Each inode maps offset → disk block for one file
 - Also contains metadata: permissions, mod times, link count, ...

5 / 42

Allocation

- Place inode of new file in same CG as directory
 - New directories go in new CG (with above average # free inodes)
- Allocate blocks to optimize for sequential access
 - If available, use rotationally close block in same cylinder (obsolete)
 - Otherwise, use block in same CG
 - If CG totally full, find other CG with quadratic hashing i.e., if CG # n is full, try $n + 1^2, n + 2^2, n + 3^2, \dots \pmod{\#CGs}$
 - Otherwise, search all CGs for some free space
 - Break big files over multiple CGs
- Fragment allocation could require moving last block a lot
 - (Partial) solution: new `stat` struct field `st_blksize`
 - stdio library buffers this much data before writing

6 / 42

Directories

- Directories have normal inodes with different type bits
- Contents considered as 512-byte *chunks*
- Each chunk has `direct` structure(s) with:
 - 32-bit number
 - 16-bit size of directory entry
 - 8-bit file type (added later)
 - 8-bit length of file name
- Coalesce when deleting
 - If first `direct` in chunk deleted, set `inumber` = 0
- Periodically compact directory chunks
 - But can never move directory entries across chunks
 - Recall only 512-byte sector writes atomic w. power failure

7 / 42

Outline

- 1 FFS in more detail
- 2 Crash recovery
- 3 Soft updates
- 4 Journaling
- 5 F2FS

8 / 42

Fixing corruption – fsck

- Must run FS check (`fsck`) program after crash
- Summary info usually bad after crash
 - Scan to check free block map, block/inode counts
- System may have corrupt inodes (not simple crash)
 - Bad block numbers, cross-allocation, etc.
 - Do sanity check, clear inodes containing garbage
- Fields in inodes may be wrong
 - Count number of directory entries to verify link count, if no entries but count \neq 0, move to `lost+found`
 - Make sure size and used data counts match blocks
- Directories may be bad
 - Holes illegal, `.` and `..` must be valid, file names must be unique
 - All directories must be reachable

9 / 42

Crash recovery permeates FS code

- Have to ensure `fsck` can recover file system
- Strawman: just write all data asynchronously
 - Any subset of data structures may be updated before a crash
- Delete/truncate a file, append to other file, crash?

10 / 42

Crash recovery permeates FS code

- Have to ensure `fsck` can recover file system
- Strawman: just write all data asynchronously
 - Any subset of data structures may be updated before a crash
- Delete/truncate a file, append to other file, crash?
 - New file may reuse block from old
 - Old inode may not be updated
 - Cross-allocation!
 - Often inode with older `mtime` wrong, but can't be sure
- Append to file, allocate indirect block, crash?

10 / 42

Crash recovery permeates FS code

- Have to ensure `fsck` can recover file system
- Strawman: just write all data asynchronously
 - Any subset of data structures may be updated before a crash
- Delete/truncate a file, append to other file, crash?
 - New file may reuse block from old
 - Old inode may not be updated
 - Cross-allocation!
 - Often inode with older `mtime` wrong, but can't be sure
- Append to file, allocate indirect block, crash?
 - Inode points to indirect block
 - But indirect block may contain garbage!

10 / 42

Sidenote: kernel-internal disk write routines

- **BSD has three ways of writing a block to disk**
- 1. `bdwrite` – **delayed write**
 - Marks cached copy of block as dirty, does not write it
 - Will get written back in background within 30 seconds
 - Used if block likely to be modified again soon
- 2. `bawrite` – **asynchronous write**
 - Start write but return immediately before it completes
 - E.g., use when appending to file and block is full
- 3. `bwrite` – **synchronous write**
 - Start write, sleep and do not return until safely on disk

11 / 42

Ordering of updates

- **Must be careful about order of updates**
 - Write new inode to disk before directory entry
 - Remove directory name before deallocating inode
 - Write cleared inode to disk before updating CG free map
- **Solution: Many metadata updates synchronous** (`bwrite`)
 - Doing one write at a time ensures ordering
 - Of course, this hurts performance
 - E.g., `untar` much slower than disk bandwidth
- **Note: Cannot update buffers on the disk queue**
 - E.g., say you make two updates to same directory block
 - But crash recovery requires first to be synchronous
 - Must wait for first write to complete before doing second
 - Makes `bawrite` as slow as `bwrite` for many updates to same block

12 / 42

Performance vs. consistency

- **FFS crash recoverability comes at huge cost**
 - Makes tasks such as `untar` easily 10–20 times slower
 - All because you *might* lose power or reboot at any time
- **Even slowing normal case does not make recovery fast**
 - If `fsck` takes one minute, then disks get 10× bigger, then 100× ...
- **One solution: battery-backed RAM**
 - Expensive (requires specialized hardware)
 - Often don't learn battery has died until too late
 - A pain if computer dies (can't just move disk)
 - If OS bug causes crash, RAM might be garbage
- **Better solution: Advanced file system techniques**
 - Next: two advanced techniques

13 / 42

Outline

- 1 FFS in more detail
- 2 Crash recovery
- 3 **Soft updates**
- 4 Journaling
- 5 F2FS

14 / 42

First attempt: Ordered updates

- **Want to avoid crashing after “bad” subset of writes**
- **Must follow 3 rules in ordering updates [Ganger]:**
 1. Never write pointer before initializing the structure it points to
 2. Never reuse a resource before nullifying all pointers to it
 3. Never clear last pointer to live resource before setting new one
- **If you do this, file system will be recoverable**
- **Moreover, can recover quickly**
 - Might leak free disk space, but otherwise correct
 - So start running after reboot, scavenge for space in background
- **How to achieve?**
 - Keep a partial order on buffered blocks

15 / 42

Ordered updates (continued)

- **Example: Create file A**
 - Block *X* contains an inode
 - Block *Y* contains a directory block
 - Create file *A* in inode block *X*, dir block *Y*
 - By rule #1, must write *X* before writing *Y*
- **We say $Y \rightarrow X$, pronounced “*Y depends on X*”**
 - Means *Y* cannot be written before *X* is written
 - *X* is called the **dependee**, *Y* the **depender**
- **Can delay both writes, so long as order preserved**
 - Say you create a second file *B* in blocks *X* and *Y*
 - Only have to write each out once for both creates

16 / 42

Problem: Cyclic dependencies

- **Suppose you create file A, unlink file B, but delay writes**
 - Both files in same directory block Y & inode block X
- **Rule #1: Must write A's inode before dir. entry ($Y \rightarrow X$)**
 - Otherwise, after crash directory will point to bogus inode
 - Worse yet, same inode # might be re-allocated
 - So could end up with file name A being an unrelated file
- **Rule #2: Must clear B's dir. entry before writing inode ($X \rightarrow Y$)**
 - Otherwise, B could end up with too small a link count
 - File could be deleted while links to it still exist
- **Otherwise, fsck has to be slow**
 - Check every directory entry and every inode link count

17 / 42

Cyclic dependencies illustrated

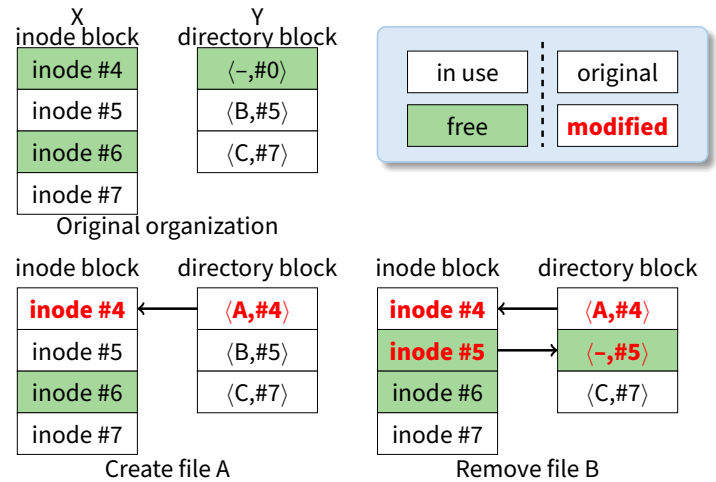

18 / 42

More problems

- **Crash might occur between ordered but related writes**
 - E.g., summary information wrong after block freed
- **Block aging**
 - Block that always has dependency will never get written back
- **Solution: Soft updates [Ganger]**
 - Write blocks in any order
 - But keep track of dependencies
 - **When writing a block, temporarily roll back any changes you can't yet commit to disk**
 - I.e., can't write block with any arrows pointing to dependees ... but can temporarily undo whatever change requires the arrow

19 / 42

Breaking dependencies with rollback

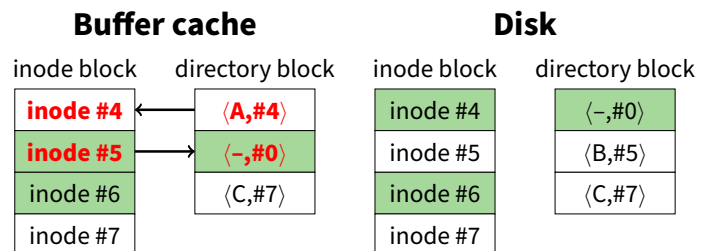

- Created file A and deleted file B
- Now say we decide to write directory block...
- Can't write file name A to disk—has dependee

20 / 42

Breaking dependencies with rollback

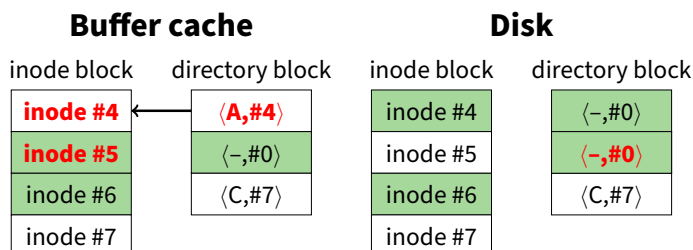

- **Undo file A before writing dir block to disk**
 - Even though we just wrote it, directory block still dirty
- **But now inode block has no dependees**
 - Can safely write inode block to disk as-is...

20 / 42

Breaking dependencies with rollback

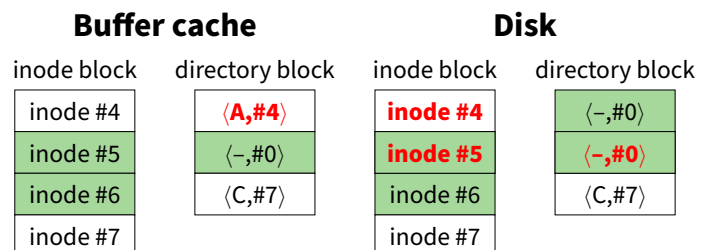

- Now inode block clean (same in memory as on disk)
- But have to write directory block a second time...

20 / 42

Breaking dependencies with rollback

Buffer cache

inode #4
inode #5
inode #6
inode #7

directory block
<A,#4>
<-,#0>
<C,#7>

Disk

inode #4
inode #5
inode #6
inode #7

directory block
<A,#4>
<-,#0>
<C,#7>

- All data stably on disk
- Crash at any point would have been safe

20 / 42

Soft updates

- Structure for each updated field or pointer, contains:
 - old value
 - new value
 - list of updates on which this update depends (*dependees*)
- Can write blocks in any order
 - But must temporarily undo updates with pending dependencies
 - Must lock rolled-back version so applications don't see it
 - Choose ordering based on disk arm scheduling
- Some dependencies better handled by postponing in-memory updates
 - E.g., when freeing block (e.g., because file truncated), just mark block free in bitmap after block pointer cleared on disk

21 / 42

Simple example

- Say you create a zero-length file *A*
- Depender: Directory entry for *A*
 - Can't be written until dependees on disk
- Dependees:
 - Inode – must be initialized before dir entry written
 - Bitmap – must mark inode allocated before dir entry written
- Old value: empty directory entry
- New value: <filename *A*, inode #>
- Can write directory block to disk any time
 - Must substitute old value until inode & bitmap updated on disk
 - Once dir block on disk contains *A*, file fully created
 - Crash before *A* on disk, worst case might leak the inode

22 / 42

Operations requiring soft updates (1)

1. Block allocation
 - Must write: disk block, free map, & pointer (in inode or ind. block)
 - Disk block & free map must be written before pointer
 - Use Undo/redo on pointer (& possibly file size)
2. Block deallocation
 - Must write: cleared pointer & free map
 - Just update free map after pointer written to disk
 - Or just immediately update free map if pointer not on disk
- Say you quickly append block to file then truncate
 - You will know pointer to block not written because of the allocated dependency structure
 - So both operations together require no disk I/O!

23 / 42

Operations requiring soft updates (2)

3. Link addition (see simple example)
 - Must write: directory entry, inode, & free map (if new inode)
 - Inode and free map must be written before dir entry
 - Use undo/redo on *i#* in dir entry (because *i# 0* ignored in dirent)
4. Link removal
 - Must write: directory entry, inode & free map (if *nlinks==0*)
 - Clear directory entry immediately
 - Must decrement *nlinks* on disk only after pointer cleared
 - Just decrement in-memory *nlinks* after directory written
 - If directory entry was never written, decrement immediately (again will know by presence of dependency structure)
- Note: Quick create/delete requires no disk I/O

24 / 42

Soft update issues

- *fsync* – syscall to flush file changes to disk
 - Must also flush directory entries, parent directories, etc.
- *unmount* – flush all changes to disk on shutdown
 - Some buffers must be flushed multiple times to get clean
- Deleting large directory trees frighteningly fast
 - *unlink* syscall returns even if inode/indir block not cached!
 - Dependencies allocated faster than blocks written
 - Cap # dependencies allocated to avoid exhausting memory
- Useless write-backs
 - Syncer flushes dirty buffers to disk every 30 seconds
 - Writing all at once means many dependencies unsatisfied
 - Fix syncer to write blocks one at a time
 - Tweak LRU buffer eviction to know about dependencies

25 / 42

Soft updates fsck

- **Split into foreground and background parts**
- **Foreground must be done before remounting FS**
 - Need to make sure per-cylinder summary info makes sense
 - Recompute free block/inode counts from bitmaps – very fast
 - Will leave FS consistent, but might leak disk space or inodes
- **Background does traditional fsck operations**
 - Do after mounting to recuperate free space
 - Can be using the file system while this is happening
 - Must be done in foreground after a media failure
- **Difference from traditional FFS fsck:**
 - May have many, many inodes with non-zero link counts
 - Don't stick them all in lost+found (unless media failure)

26 / 42

Outline

- 1 FFS in more detail
- 2 Crash recovery
- 3 Soft updates
- 4 **Journaling**
- 5 F2FS

27 / 42

An alternative: Journaling

- **Biggest crash-recovery challenge is inconsistency**
 - Have one logical operation (e.g., create or delete file)
 - Requires multiple separate disk writes
 - If only some of them happen, end up with big problems
- **Most of these problematic writes are to metadata**
- **Idea: Use a *write-ahead log* to *journal* metadata**
 - Reserve a portion of disk for a log
 - Write any metadata operation first to log, then to disk
 - After crash/reboot, re-play the log (efficient)
 - May re-do already committed change, but won't miss anything

28 / 42

Journaling (continued)

- **Group multiple operations into one log entry**
 - E.g., clear directory entry, clear inode, update free map— either all three will happen after recovery, or none
- **Performance advantage:**
 - Log is consecutive portion of disk
 - Multiple operations can be logged at disk b/w
 - Safe to consider updates committed when written to log
- **Example: delete directory tree**
 - Record all freed blocks, changed directory entries in log
 - Return control to user
 - Write out changed directories, bitmaps, etc. in background (sort for good disk arm scheduling)

29 / 42

Journaling details

- **Must find oldest relevant log entry**
 - Otherwise, redundant and slow to replay whole log
 - Worse, old directory/indirect blocks reallocated as data could get corrupted by old replay (because only metadata logged)
- **Use checkpoints**
 - Once all records up to log entry N have been processed and affected blocks stably committed to disk...
 - Record N to disk either in reserved checkpoint location, or in checkpoint log record
 - Never need to go back before most recent checkpointed N
- **Must also find end of log**
 - Typically circular buffer; don't play old records out of order
 - Can include begin transaction/end transaction records
 - Also typically have checksum in case some sectors bad

30 / 42

Case study: XFS [Sweeney]

- **Main idea: Think big**
 - Big disks, files, large # of files, 64-bit everything
 - Yet maintain very good performance
- **Break disk up into *Allocation Groups* (AGs)**
 - 0.5 – 4 GiB regions of disk
 - New directories go in new AGs
 - Within directory, inodes of files go in same AG
 - Unlike cylinder groups, AGs too large to minimize seek times
 - Unlike cylinder groups, no fixed # of inodes per AG
- **Advantages of AGs:**
 - Parallelize allocation of blocks/inodes on multiprocessor (independent locking of different free space structures)
 - Can use 32-bit block pointers within AGs (keeps data structures smaller)

31 / 42

B+-trees

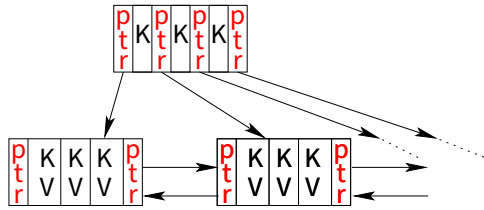

- **XFS makes extensive use of B+-trees**
 - Indexed data structure stores ordered Keys & Values
 - Keys must have an ordering defined on them
 - Stored data in blocks for efficient disk access
- **For B+-tree with n items, all operations $O(\log n)$:**
 - Retrieve closest $\langle \text{key}, \text{value} \rangle$ to target key k
 - Insert a new $\langle \text{key}, \text{value} \rangle$ pair
 - Delete $\langle \text{key}, \text{value} \rangle$ pair

32 / 42

B+-trees continued

- See any algorithms book for details (e.g., [Cormen])
- **Some operations on B-tree are complex:**
 - E.g., insert item into completely full B+-tree
 - May require “splitting” nodes, adding new level to tree
 - Would be bad to crash & leave B+-tree in inconsistent state
- **Journal enables atomic complex operations**
 - First write all changes to the log
 - If crash while writing log, incomplete log record will be discarded, and no change made
 - Otherwise, if crash while updating B+-tree, will replay entire log record and write everything

33 / 42

B+-trees in XFS

- **B+-trees are complex to implement**
 - But once you’ve done it, might as well use everywhere
- **Use B+-trees for directories (keyed on filename hash)**
 - Makes large directories efficient
- **Make each inode a B+-tree**
 - No more FFS-style fixed block pointers
 - Instead, B+-tree maps: file offset \rightarrow $\langle \text{start block}, \# \text{ blocks} \rangle$
 - Ideally file is one or small number of contiguous extents
 - Allows small inodes & no indirect blocks even for huge files
- **Use B+-tree to map inumber to location of inode**
 - High bits of inumber specify AG, middle bits are key in per-AG B+-tree, last few bits are position in a block of inodes
 - B+-tree in AG maps: starting $i\# \rightarrow$ $\langle \text{block } \#, \text{ free-map} \rangle$
 - So free inodes tracked right in leaf of B+-tree

34 / 42

More B+-trees in XFS

- **Free extents tracked by two B+-trees**
 1. start block # \rightarrow # free blocks
 2. # free blocks \rightarrow start block #
- **Use journal to update both atomically & consistently**
- **#1 allows you to coalesce adjacent free regions**
- **#1 allows you to allocate near some target**
 - E.g., when extending file, put next block near previous one
 - When first writing to file, put data near inode
- **#2 allows you to do best fit allocation**
 - Leave large free extents for large files

35 / 42

Contiguous allocation

- **Ideally want each file contiguous on disk**
 - Sequential file I/O should be as fast as sequential disk I/O
 - Also keeps inodes small (fewer extents to index in B+-tree)
- **But how do you know how large a file will be?**
- **Idea: delayed allocation**
 - `write` syscall only affects the buffer cache
 - Allow write into buffers before deciding where to place on disk
 - Assign disk space only when buffers are flushed
- **Other advantages:**
 - Short-lived files never need disk space allocated
 - `mmaped` files often written in random order in memory, but will be written to disk mostly contiguously
 - Write clustering: find other nearby stuff to write to disk

36 / 42

Journaling vs. soft updates

- **Both much better than FFS alone**
- **Some limitations of soft updates**
 - Very specific to FFS data structures (E.g., couldn’t easily add B-trees like XFS—even directory rename not quite right)
 - Metadata updates may proceed out of order (E.g., create A , create B , crash—maybe only B exists after reboot)
 - Still need slow background `fsck` to reclaim space
- **Some limitations of journaling**
 - Disk write required for every metadata operation (whereas create-then-delete might require no I/O with soft updates)
 - Possible contention for end of log on multi-processor
 - `fsync` must sync other operations’ metadata to log, too

37 / 42

Outline

- 1 FFS in more detail
- 2 Crash recovery
- 3 Soft updates
- 4 Journaling
- 5 F2FS

38 / 42

Flash-Friendly File System (F2FS) [Lee]

- File system targeted at flash devices with FTL (e.g., SSDs)
 - Try to do mostly large sequential writes
 - *Don't* attempt to do wear leveling (since have FTL anyway)
 - See also [Brown]
- Break disk up into:
 - Blocks – 4 KiB
 - Segments – 512 blocks, chosen so one block fits segment summary
 - Sections – 2^i segments (default $i = 0$), unit of log cleaning
 - Zones – n sections (default $n = 1$), if device internally comprises “subdevices,” send parallel IO to different zones
- Split device in two parts:
 - Main area, in which to perform large sequential writes
 - Smaller metadata area has random writes, relies on FTL

39 / 42

F2FS layout

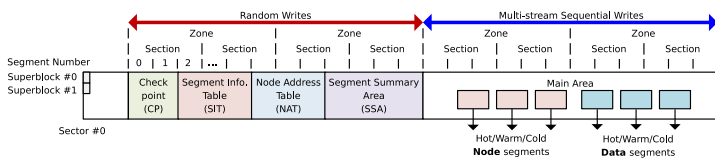

- CP – Valid SIT/NAT sets, list of orphan (open+deleted) inodes
 - Place version # in header+footer, use consistent CP with highest #
- SIT – Per-segment block validity bitmap and count
 - Two SIT areas and a small journal avoids updating in place
 - CP says which SIT area is active
- NAT – Translates node numbers to actual block storing node
 - Updated like SIT
- SSA – Parent info for each block (e.g., inode+offset)
 - Just updated in place, CP records active ones to recover

40 / 42

F2FS inode

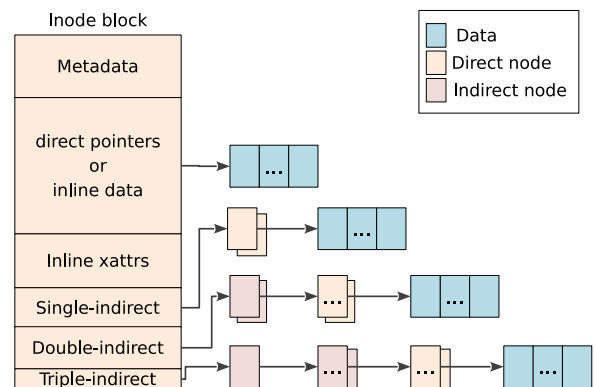

- Small files (<3,692 bytes) stored “inline” inside inode
- Node pointers use NAT table for level of indirection
 - Lets F2FS move a node without updating parent pointers

41 / 42

Multi-head logging

Type	Temp.	Objects
Node	Hot	Direct node blocks for directories
	Warm	Direct node blocks for regular files
	Cold	Indirect node blocks
Data	Hot	Directory entry blocks
	Warm	Data blocks made by users
	Cold	Data blocks moved by cleaning; Cold data blocks specified by users; Multimedia file data

- Two kinds of cleaning foreground and background
 - Foreground (only if needed) greedily cleans most free section
 - Background just loads blocks into buffer cache and marks dirty
- With no disk head, can efficiently maintain multiple logs
 - Group data by similar expected lifetime (see above)
 - Means can clean empty or mostly empty sections

42 / 42