

File system fun

- **File systems: traditionally hardest part of OS**
 - Historically, more papers on FSES than any other single topic
- **Main tasks of file system:**
 - Associate bytes with name (files)
 - Associate names with each other (directories)
 - Don't go away (ever)
 - Can implement file systems on disk, over network, in memory, in non-volatile ram (NVRAM), on tape, w/ paper.
 - We'll focus on disk and generalize later
- **Today: files, directories, and a bit of performance**

1 / 38

Why disks are different

- **Disk = First state we've seen that doesn't go away**

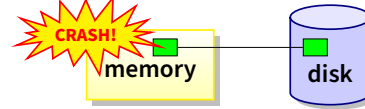

- So: Where all important state ultimately resides
- **Slow (milliseconds access vs. nanoseconds for memory)**
- **Huge (64–1,000x bigger than memory)**
 - How to organize large collection of ad hoc information?
 - File System: Hierarchical directories, Metadata, Search

2 / 38

Disk vs. Memory

	Disk	TLC NAND Flash	DRAM
Smallest write	sector	sector	byte
Atomic write	sector	sector	byte/word
Random read	8 ms	3-10 μ s	50 ns
Random write	8 ms	9-11 μ s*	50 ns
Sequential read	200 MB/s	550–2500 MB/s	> 10 GB/s
Sequential write	200 MB/s	520–1500 MB/s*	> 10 GB/s
Cost normally	\$0.01–0.02/GB	\$0.06–0.10/GB	\$1.60–2.50/GiB
Cost today	\$0.02–0.04/GB	\$0.17–0.27/GB	\$22–35/GiB**
Persistence	Non-volatile	Non-volatile	Volatile

*Flash write performance degrades over time

**Listed price is for DDR5 RDIMMs; UDIMMs closer to \$13

3 / 38

Disk review

- **Disk reads/writes in terms of sectors, not bytes**
 - Read/write single sector or adjacent groups



- **How to write a single byte? “Read-modify-write”**

- Read in sector containing the byte
- Modify that byte
- Write entire sector back to disk
- Key: if cached, don't need to read in

- **Sector = unit of atomicity.**

- Sector write done completely, even if crash in middle (disk saves up enough momentum to complete)

- **Larger atomic units have to be synthesized by OS**

4 / 38

Some useful trends

- **Disk b/w, cost/bit historically improved exponentially**
 - Similar to CPU speed, memory size, etc.
- **Seek time and rotational delay improving very slowly**
 - Why? require moving physical object (disk arm)
- **Disk accesses a huge system bottleneck & getting worse**
 - Bandwidth increase lets system (pre-)fetch large chunks for about the same cost as small chunk.
 - Trade bandwidth for latency if you can get lots of related stuff.
- **Desktop memory size increases faster than typical workloads**
 - (At list historically) more and more of workload fits in file cache
 - Disk traffic changes: mostly writes and new data
- **(Historically) Memory and CPU resources increasing**
 - Use memory and CPU to make better decisions
 - Complex prefetching to support more IO patterns
 - Delay data placement decisions to reduce random IO

5 / 38

Files: named bytes on disk

- **File abstraction:**

- User's view: named sequence of bytes

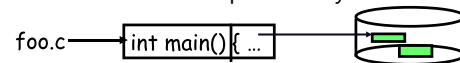

- FS's view: collection of disk blocks
- File system's job: translate name & offset to disk blocks:



- **File operations:**

- Create a file, delete a file
- Read from file, write to file

- **Want: operations to have as few disk accesses as possible & have minimal space overhead (group related things)**

6 / 38

What's hard about grouping blocks?

- Like page tables, file system metadata are simply data structures used to construct mappings

- Page table: map virtual page # to physical page #



- File metadata: map byte offset to disk block address



- Directory: map name to disk address or file #



7 / 38

FS vs. VM

- In both settings, want location transparency
 - Application shouldn't care about particular disk blocks or physical memory locations
- In some ways, FS has easier job than than VM:
 - CPU time to do FS mappings not a big deal (= no TLB)
 - Page tables deal with sparse address spaces and random access, files often denser ($0 \dots \text{filesize} - 1$), ~sequentially accessed
- In some ways FS's problem is harder:
 - Each layer of translation = potential disk access
 - Space a huge premium! (But disk is huge?!?!?) Reason? Cache space never enough; amount of data you can get in one fetch never enough
 - Range very extreme: Many files <10 KiB, some files many GiB

8 / 38

Some working intuitions

- FS performance dominated by # of disk accesses
 - Say each access costs ~10 milliseconds
 - Touch the disk 100 extra times = 1 second
 - Can do billions of ALU ops in same time!
- Access cost dominated by movement, not transfer:

seek time + rotational delay + # bytes/disk-bw

 - 1 sector: $5\text{ms} + 4\text{ms} + 5\mu\text{s}$ ($\approx 512 \text{ B} / (100 \text{ MB/s}) \approx 9\text{ms}$)
 - 50 sectors: $5\text{ms} + 4\text{ms} + .25\text{ms} = 9.25\text{ms}$
 - Can get 50x the data for only ~3% more overhead!
- Observations that might be helpful:
 - All blocks in file tend to be used together, sequentially
 - All files in a directory tend to be used together
 - All names in a directory tend to be used together

9 / 38

Common addressing patterns

- Sequential:
 - File data processed in sequential order
 - By far the most common mode
 - Example: editor writes out new file, compiler reads in file, etc.
- Random access:
 - Address any block in file directly without passing through predecessors
 - Examples: data set for demand paging, databases
- Keyed access
 - Search for block with particular values
 - Examples: associative data base, index
 - Usually not provided by OS, but implementation assumes file systems optimize first two

10 / 38

Problem: how to track file's data

- Disk management:
 - Need to keep track of where file contents are on disk
 - Must be able to use this to map byte offset to disk block
 - Structure tracking a file's sectors is called an index node or *inode*
 - Inodes must be stored on disk, too
- Things to keep in mind while designing file structure:
 - Most files are small
 - Much of the disk is allocated to large files
 - Many of the I/O operations are made to large files
 - Want good sequential and good random access (what do these require?)

11 / 38

Straw man: contiguous allocation

- "Extent-based": allocate files like segmented memory
 - When creating a file, make the user pre-specify its length and allocate all space at once
 - Inode contents: location and size

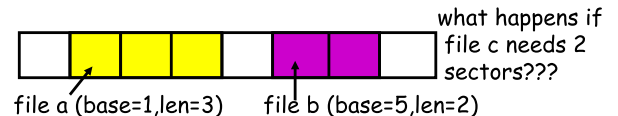

- Example: IBM OS/360
- Pros?
- Cons? (Think of corresponding VM scheme)

12 / 38

Straw man: contiguous allocation

- **“Extent-based”:** allocate files like segmented memory
 - When creating a file, make the user pre-specify its length and allocate all space at once
 - Inode contents: location and size

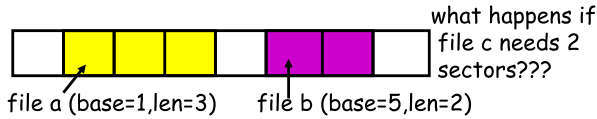

- **Example: IBM OS/360**
- **Pros?**
 - Simple, fast access, both sequential and random
- **Cons? (Think of corresponding VM scheme)**
 - External fragmentation

12 / 38

Straw man #2: Linked files

- **Basically a linked list on disk.**
 - Keep a linked list of all free blocks
 - Inode contents: a pointer to file's first block
 - In each block, keep a pointer to the next one

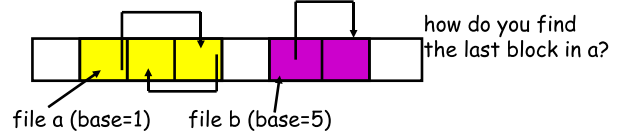

- **Examples (sort-of):** Alto, TOPS-10, DOS FAT
- **Pros?**
- **Cons?**

13 / 38

Straw man #2: Linked files

- **Basically a linked list on disk.**
 - Keep a linked list of all free blocks
 - Inode contents: a pointer to file's first block
 - In each block, keep a pointer to the next one

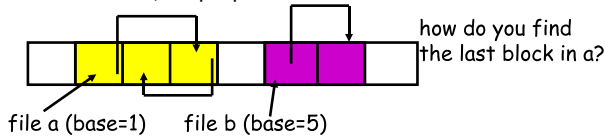

- **Examples (sort-of):** Alto, TOPS-10, DOS FAT
- **Pros?**
 - Easy dynamic growth & sequential access, no fragmentation
- **Cons?**
 - Linked lists on disk a bad idea because of access times
 - Random very slow (e.g., traverse whole file to find last block)
 - Pointers take up room in block, skewing alignment

13 / 38

Example: DOS FS (simplified)

- **Linked files with key optimization:** puts links in fixed-size “file allocation table” (FAT) rather than in the blocks.

Directory (5) FAT (16-bit entries)

a: 6
b: 2

0	free
1	eof
2	1
3	eof
4	3
5	eof
6	4
...	...

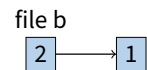
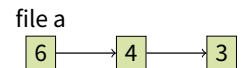

- **Still do pointer chasing, but can cache entire FAT so can be cheap compared to disk access**

14 / 38

FAT discussion

- **Entry size = 16 bits**
 - What's the maximum size of the FAT?
 - Given a 512 byte block, what's the maximum size of FS?
 - One solution: go to bigger blocks. Pros? Cons?
- **Space overhead of FAT is trivial:**
 - 2 bytes / 512 byte block = ~ 0.4% (Compare to Unix)
- **Reliability: how to protect against errors?**
 - Create duplicate copies of FAT on disk
 - State duplication a very common theme in reliability
- **Bootstrapping: where is root directory?**
 - Fixed location on disk:

FAT	(opt) FAT	root dir	...
-----	-----------	----------	-----

15 / 38

FAT discussion

- **Entry size = 16 bits**
 - What's the maximum size of the FAT? **65,536 entries**
 - Given a 512 byte block, what's the maximum size of FS? **32 MiB**
 - One solution: go to bigger blocks. Pros? Cons?
- **Space overhead of FAT is trivial:**
 - 2 bytes / 512 byte block = ~ 0.4% (Compare to Unix)
- **Reliability: how to protect against errors?**
 - Create duplicate copies of FAT on disk
 - State duplication a very common theme in reliability
- **Bootstrapping: where is root directory?**
 - Fixed location on disk:

FAT	(opt) FAT	root dir	...
-----	-----------	----------	-----

15 / 38

Another approach: Indexed files

- Each file has an array holding all of its block pointers
 - Just like a page table, so will have similar issues
 - Max file size fixed by array's size (static or dynamic?)
 - Allocate array to hold file's block pointers on file creation
 - Allocate actual blocks on demand using free list

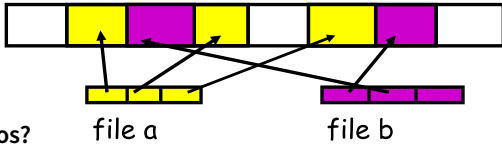

- Pros?
- Cons?

16 / 38

Another approach: Indexed files

- Each file has an array holding all of its block pointers
 - Just like a page table, so will have similar issues
 - Max file size fixed by array's size (static or dynamic?)
 - Allocate array to hold file's block pointers on file creation
 - Allocate actual blocks on demand using free list

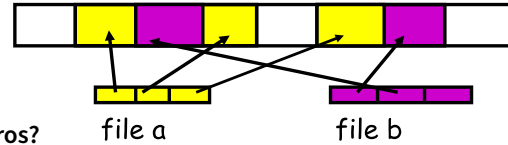

- Pros?
 - Both sequential and random access easy
- Cons?
 - Mapping table requires large chunk of contiguous space ... Same problem we were trying to solve initially

16 / 38

Indexed files

- Issues same as in page tables

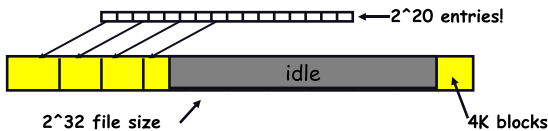

- Large possible file size = lots of unused entries
- Large actual size? table needs large contiguous disk chunk
- Solve identically: small regions with index array, this array with another array, ... Downside?



17 / 38

Multi-level indexed files (old BSD FS)

- Solve problem of first block access slow
- inode = 14 block pointers + "stuff"

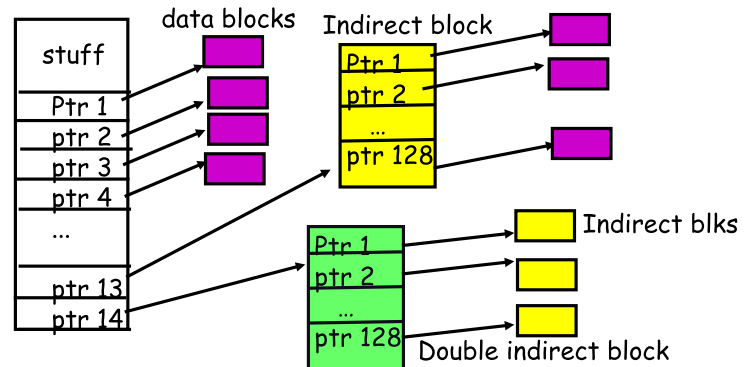

18 / 38

Old BSD FS discussion

- Pros:
 - Simple, easy to build, fast access to small files
 - Maximum file length fixed, but large.
- Cons:
 - What is the worst case # of accesses?
 - What is the worst-case space overhead? (e.g., 13 block file)
- An empirical problem:
 - Because you allocate blocks by taking them off unordered freelist, metadata and data get strewn across disk

19 / 38

More about inodes

- Inodes are stored in a fixed-size array
 - Size of array fixed when disk is initialized; can't be changed
 - Lives in known location, originally at one side of disk:

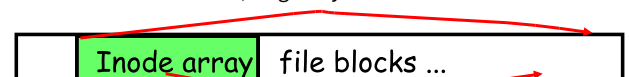

- Now is smeared across it (why?)

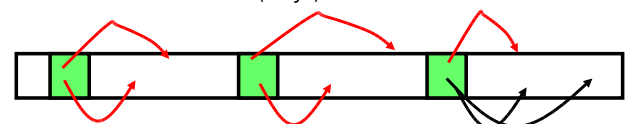

- The index of an inode in the inode array called an i-number
- Internally, the OS refers to files by inumber
- When file is opened, inode brought in memory
- Written back when modified and file closed or time elapses

20 / 38

Directories

- **Problem:**
 - “Spend all day generating data, come back the next morning, want to use it.” – F. Corbató, on why files/dirs invented
- **Approach 0: Users remember where on disk their files are**
 - E.g., like remembering your social security or bank account #
- **Yuck. People want human digestible names**
 - We use directories to map names to file blocks
- **Next: What is in a directory and why?**

21 / 38

A short history of directories

- **Approach 1: Single directory for entire system**
 - Put directory at known location on disk
 - Directory contains `<name, inumber>` pairs
 - If one user uses a name, no one else can
 - Many ancient personal computers work this way
- **Approach 2: Single directory for each user**
 - Still clumsy, and 1s on 10,000 files is a real pain
- **Approach 3: Hierarchical name spaces**
 - Allow directory to map names to files *or other dirs*
 - File system forms a tree (or graph, if links allowed)
 - Large name spaces tend to be hierarchical (ip addresses, domain names, scoping in programming languages, etc.)

22 / 38

Hierarchical Unix

- **Used since CTSS (1960s)**
 - Unix picked up and used really nicely
- **Directories stored on disk just like regular files**
 - Special inode type byte set to directory
 - Users can read just like any other file (historically)
 - Only special syscalls can write (why?)
 - Inodes at fixed disk location
 - File pointed to by the index may be another directory
 - Makes FS into hierarchical tree (what needed to make a DAG?)
- **Simple, plus speeding up file ops speeds up dir ops!**



```

<name, inode#>
<afs, 1021>
<tmp, 1020>
<bin, 1022>
<cdrom, 4123>
<dev, 1001>
<sbin, 1011>
:
  
```

23 / 38

Naming magic

- **Bootstrapping: Where do you start looking?**
 - Root directory always inode #2 (0 and 1 historically reserved)
- **Special names:**
 - Root directory: “/” (fixed by kernel—e.g., inode 2)
 - Current directory: “.” (actual directory entry on disk)
 - Parent directory: “..” (actual directory entry on disk)
- **Some special names are provided by shell, not FS:**
 - User’s home directory: “~”
 - Globbing: “foo.*” expands to all files starting “foo.”
- **Using the given names, only need two operations to navigate the entire name space:**
 - `cd name`: move into (change context to) directory *name*
 - `ls`: enumerate all names in current directory (context)

24 / 38

Unix example: /a/b/c.c

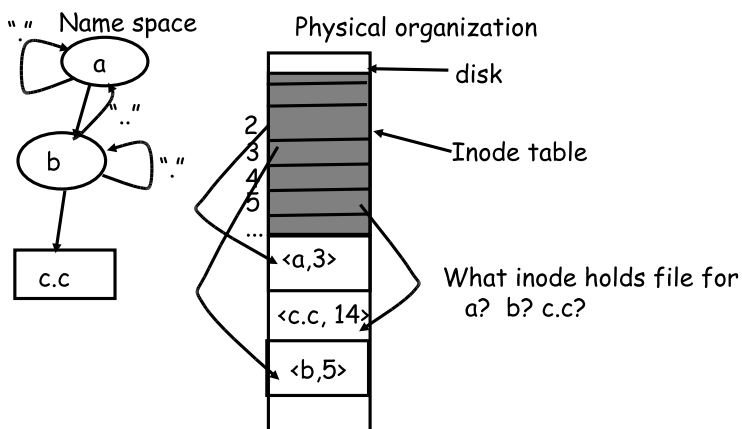

25 / 38

Default context: working directory

- **Cumbersome to constantly specify full path names**
 - In Unix, each process has a “current working directory” (cwd)
 - File names not beginning with “/” are assumed to be relative to cwd; otherwise translation happens as before
 - Editorial: root, cwd should be regular fds (like stdin, stdout, ...) with `openat` syscall instead of `open`
 - ▶ In modern linux `open` in libc calls `openat(AT_FDCWD, ...)` syscall
- **Shells track a default list of active contexts**
 - A “search path” for programs you run
 - Given a search path `A : B : C`, a shell will check in A, then check in B, then check in C
 - Can escape using explicit paths: “./foo”
- **Example of locality**

26 / 38

Hard and soft links (synonyms)

- More than one dir entry can refer to a given file

- Unix stores count of pointers ("hard links") to inode
- To make: `ln foo bar` creates a synonym (`bar`) for file `foo`

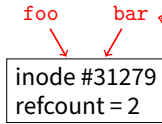

- Soft/symbolic links = synonyms for names

- Point to a file (or dir) name, but object can be deleted from underneath it (or never even exist).
- Unix implements like directories: inode has special "symlink" bit set and contains name of link target

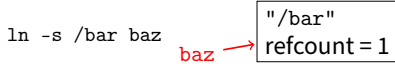

- When the file system encounters a symbolic link it automatically translates it (if possible).

27 / 38

Case study: speeding up FS

- Original Unix FS: Simple and elegant:

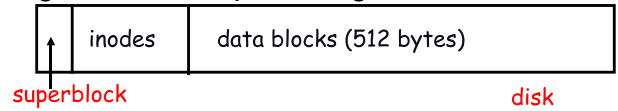

- Components:

- Data blocks
- Inodes (directories represented as files)
- Hard links
- Superblock. (specifies number of blks in FS, max # of files, pointer to head of free list)

- Problem: slow

- Only gets 20Kb/sec (2% of disk maximum) even for sequential disk transfers!

28 / 38

A plethora of performance costs

- Blocks too small (512 bytes)

- File index too large
- Too many layers of mapping indirection
- Transfer rate low (get one block at time)

- Poor clustering of related objects:

- Consecutive file blocks not close together
- Inodes far from data blocks
- Inodes for files in same directory not close together
- Poor enumeration performance: e.g., `ls -l`, `grep foo *.c`

- Usability problems

- 14-character file names a pain
- Can't atomically update file in crash-proof way

- Next: how FFS fixes these (to a degree) [McKusick]

29 / 38

Problem: Internal fragmentation

- Block size was too small in Unix FS

- Why not just make block size bigger?

Block size	space wasted	file bandwidth
512	6.9%	2.6%
1024	11.8%	3.3%
2048	22.4%	6.4%
4096	45.6%	12.0%
1MB	99.0%	97.2%

- Bigger block increases bandwidth, but how to deal with wastage ("internal fragmentation")?

- Use idea from malloc: split unused portion.

30 / 38

Solution: fragments

- BSD FFS:

- Has large block size (4096 or 8192)
- Allow large blocks to be chopped into small ones ("fragments")
- Used for little files and pieces at the ends of files

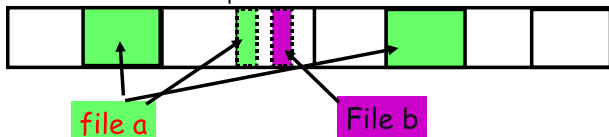

- Best way to eliminate internal fragmentation?

- Variable sized splits of course
- Why does FFS use fixed-sized fragments (1024, 2048)?

31 / 38

Clustering related objects in FFS

- Group sets of consecutive cylinders into "cylinder groups"

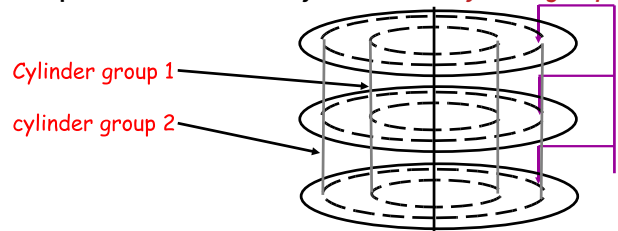

- Key: can access any block in a cylinder without performing a seek. Next fastest place is adjacent cylinder.
- Tries to put everything related in same cylinder group
- Tries to put everything not related in different group

32 / 38

Clustering in FFS

- Tries to put sequential blocks in adjacent sectors
 - (Access one block, probably access next)

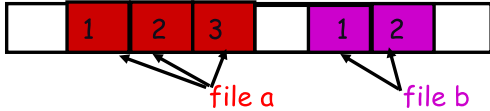

- Tries to keep inode in same cylinder group as file data:
 - (If you look at inode, most likely will look at data too)

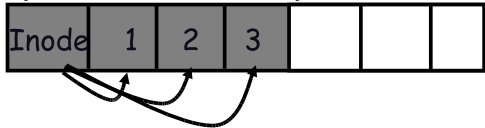

- Tries to keep all inodes in a dir in same cylinder group
 - Access one name, frequently access many, e.g., “ls -l”

33 / 38

What does disk layout look like?

- Each cylinder group basically a mini-Unix file system:

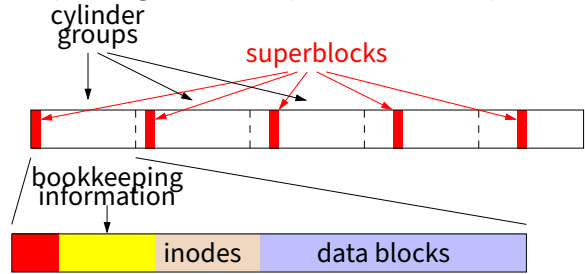

- How to ensure there's space for related stuff?
 - Place different directories in different cylinder groups
 - Keep a “free space reserve” so can allocate near existing things
 - When file grows too big (1MB) send its remainder to different cylinder group.

34 / 38

Finding space for related objs

- Old Unix (& DOS): Linked list of free blocks

- Just take a block off of the head. Easy.

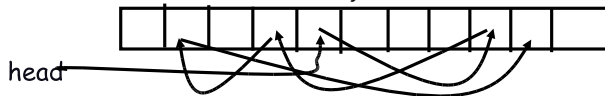

- Bad: free list gets jumbled over time. Finding adjacent blocks hard and slow

- FFS: switch to bit-map of free blocks
 - 101010111111100001111110001011100
 - Easier to find contiguous blocks.
 - Small, so usually keep entire thing in memory
 - Time to find free block increases if fewer free blocks

35 / 38

Using a bitmap

- Usually keep entire bitmap in memory:
 - 4G disk / 4K byte blocks. How big is map?
- Allocate block close to block x?
 - Check for blocks near $bmap[x/32]$
 - If disk almost empty, will likely find one near
 - As disk becomes full, search becomes more expensive and less effective
- Trade space for time (search time, file access time)
- Keep a reserve (e.g, 10%) of disk always free, ideally scattered across disk
 - Don't tell users (df can get to 110% full)
 - Only root can allocate blocks once FS 100% full
 - With 10% free, can almost always find one of them free

36 / 38

So what did we gain?

- Performance improvements:
 - Able to get 20-40% of disk bandwidth for large files
 - 10-20x original Unix file system!
 - Better small file performance (why?)
- Is this the best we can do? No.
- Block based rather than extent based
 - Could have named contiguous blocks with single pointer and length (Linux ext4fs, XFS)
- Writes of metadata done synchronously
 - Really hurts small file performance
 - Make asynchronous with write-ordering (“soft updates”) or logging/journaling... more next lecture
 - Play with semantics (/tmp file systems)

37 / 38

Other hacks

- Obvious:
 - Big file cache
- Fact: no rotation delay if get whole track.
 - How to use?
- Fact: transfer cost negligible.
 - Recall: Can get 50x the data for only ~3% more overhead
 - 1 sector: $5ms + 4ms + 5\mu s (\approx 512 B / (100 MB/s)) \approx 9ms$
 - 50 sectors: $5ms + 4ms + .25ms = 9.25ms$
 - How to use?
- Fact: if transfer huge, seek + rotation negligible
 - LFS: Hoard data, write out MB at a time
- Next lecture:
 - FFS in more detail
 - More advanced, modern file systems

38 / 38