

File system fun

- **File systems: traditionally hardest part of OS**
 - Historically, more papers on FSES than any other single topic
- **Main tasks of file system:**
 - Associate bytes with name (files)
 - Associate names with each other (directories)
 - Don't go away (ever)
 - Can implement file systems on disk, over network, in memory, in non-volatile ram (NVRAM), on tape, w/ paper.
 - We'll focus on disk and generalize later
- **Today: files, directories, and a bit of performance**

Why disks are different

- Disk = First state we've seen that doesn't go away

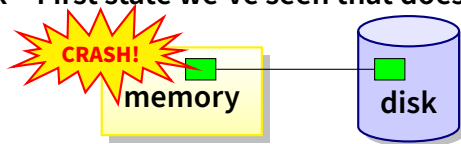

- So: Where all important state ultimately resides
- Slow (milliseconds access vs. nanoseconds for memory)

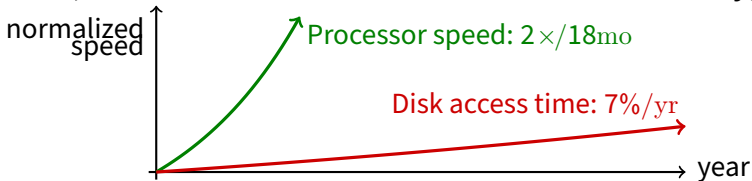

- Huge (64–1,000x bigger than memory)
 - How to organize large collection of ad hoc information?
 - File System: Hierarchical directories, Metadata, Search

Disk vs. Memory

	Disk	TLC NAND Flash	DRAM
Smallest write	sector	sector	byte
Atomic write	sector	sector	byte/word
Random read	8 ms	3-10 μ s	50 ns
Random write	8 ms	9-11 μ s*	50 ns
Sequential read	200 MB/s	550-2500 MB/s	> 10 GB/s
Sequential write	200 MB/s	520-1500 MB/s*	> 10 GB/s
Cost normally	\$0.01-0.02/GB	\$0.06-0.10/GB	\$1.60-2.50/GiB
Cost today	\$0.02-0.04/GB	\$0.17-0.27/GB	\$22-35/GiB**
Persistence	Non-volatile	Non-volatile	Volatile

*Flash write performance degrades over time

**Listed price is for DDR5 RDIMMs; UDIMMs closer to \$13

Disk review

- **Disk reads/writes in terms of sectors, not bytes**

- Read/write single sector or adjacent groups



- **How to write a single byte? “Read-modify-write”**

- Read in sector containing the byte



- Modify that byte

- Write entire sector back to disk



- Key: if cached, don't need to read in

- **Sector = unit of atomicity.**



- Sector write done completely, even if crash in middle (disk saves up enough momentum to complete)

- **Larger atomic units have to be synthesized by OS**

Some useful trends

- **Disk b/w, cost/bit historically improved exponentially**
 - Similar to CPU speed, memory size, etc.
- **Seek time and rotational delay improving very slowly**
 - Why? require moving physical object (disk arm)
- **Disk accesses a huge system bottleneck & getting worse**
 - Bandwidth increase lets system (pre-)fetch large chunks for about the same cost as small chunk.
 - Trade bandwidth for latency if you can get lots of related stuff.
- **Desktop memory size increases faster than typical workloads**
 - (At list historically) more and more of workload fits in file cache
 - Disk traffic changes: mostly writes and new data
- **(Historically) Memory and CPU resources increasing**
 - Use memory and CPU to make better decisions
 - Complex prefetching to support more IO patterns
 - Delay data placement decisions to reduce random IO

Files: named bytes on disk

- **File abstraction:**

- User's view: named sequence of bytes

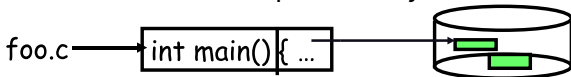

- FS's view: collection of disk blocks
- File system's job: translate name & offset to disk blocks:



- **File operations:**

- Create a file, delete a file
- Read from file, write to file

- **Want: operations to have as few disk accesses as possible & have minimal space overhead (group related things)**

What's hard about grouping blocks?

- Like page tables, file system metadata are simply data structures used to construct mappings

- Page table: map virtual page # to physical page #



- File metadata: map byte offset to disk block address

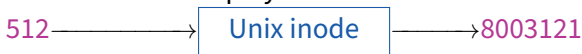

- Directory: map name to disk address or file #



FS vs. VM

- **In both settings, want location transparency**
 - Application shouldn't care about particular disk blocks or physical memory locations
- **In some ways, FS has easier job than than VM:**
 - CPU time to do FS mappings not a big deal (= no TLB)
 - Page tables deal with sparse address spaces and random access, files often denser ($0 \dots \text{filesize} - 1$), \sim sequentially accessed
- **In some ways FS's problem is harder:**
 - Each layer of translation = potential disk access
 - Space a huge premium! (But disk is huge!?!?) Reason? Cache space never enough; amount of data you can get in one fetch never enough
 - Range very extreme: Many files < 10 KiB, some files many GiB

Some working intuitions

- **FS performance dominated by # of disk accesses**

- Say each access costs ~ 10 milliseconds
- Touch the disk 100 extra times = 1 *second*
- Can do *billions* of ALU ops in same time!

- **Access cost dominated by movement, not transfer:**

seek time + **rotational delay** + # bytes/disk-bw

- 1 sector: $5\text{ms} + 4\text{ms} + 5\mu\text{s}$ ($\approx 512 \text{ B}/(100 \text{ MB/s})$) $\approx 9\text{ms}$
- 50 sectors: $5\text{ms} + 4\text{ms} + .25\text{ms} = 9.25\text{ms}$
- Can get **50x the data for only $\sim 3\%$ more overhead!**

- **Observations that might be helpful:**

- All blocks in file tend to be used together, sequentially
- All files in a directory tend to be used together
- All names in a directory tend to be used together

Common addressing patterns

- **Sequential:**
 - File data processed in sequential order
 - By far the most common mode
 - Example: editor writes out new file, compiler reads in file, etc.
- **Random access:**
 - Address any block in file directly without passing through predecessors
 - Examples: data set for demand paging, databases
- **Keyed access**
 - Search for block with particular values
 - Examples: associative data base, index
 - Usually not provided by OS, but implementation assumes file systems optimize first two

Problem: how to track file's data

- **Disk management:**

- Need to keep track of where file contents are on disk
- Must be able to use this to map byte offset to disk block
- Structure tracking a file's sectors is called an index node or *inode*
- Inodes must be stored on disk, too

- **Things to keep in mind while designing file structure:**

- Most files are small
- Much of the disk is allocated to large files
- Many of the I/O operations are made to large files
- Want good sequential and good random access (what do these require?)

Straw man: contiguous allocation

- “Extent-based”: allocate files like segmented memory

- When creating a file, make the user pre-specify its length and allocate all space at once
- Inode contents: location and size

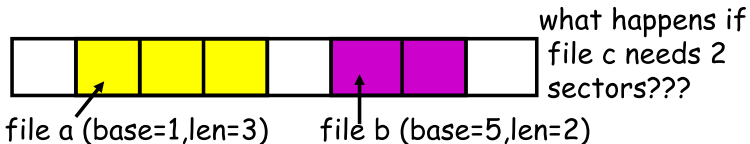

- Example: IBM OS/360

- Pros?

- Cons? (Think of corresponding VM scheme)

Straw man: contiguous allocation

- “Extent-based”: allocate files like segmented memory

- When creating a file, make the user pre-specify its length and allocate all space at once
- Inode contents: location and size

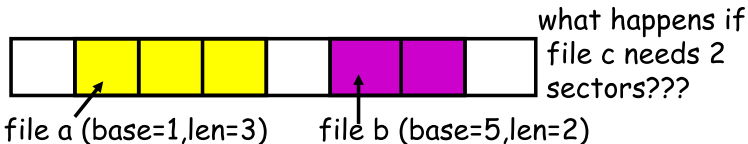

- Example: IBM OS/360

- Pros?

- Simple, fast access, both sequential and random

- Cons? (Think of corresponding VM scheme)

- External fragmentation

Straw man #2: Linked files

- **Basically a linked list on disk.**
 - Keep a linked list of all free blocks
 - Inode contents: a pointer to file's first block
 - In each block, keep a pointer to the next one

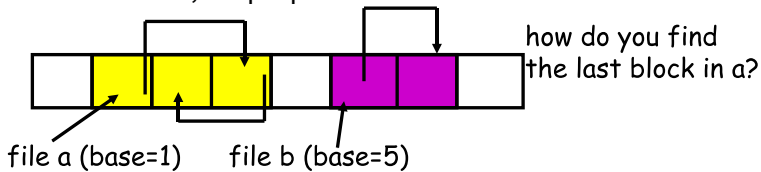

- **Examples (sort-of): Alto, TOPS-10, DOS FAT**
- **Pros?**
- **Cons?**

Straw man #2: Linked files

- **Basically a linked list on disk.**
 - Keep a linked list of all free blocks
 - Inode contents: a pointer to file's first block
 - In each block, keep a pointer to the next one

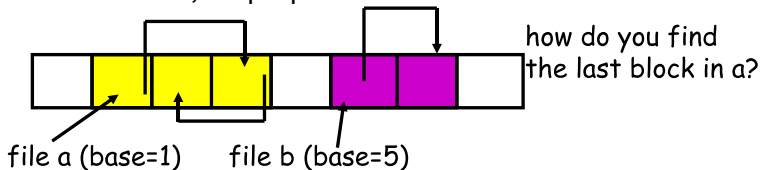

- **Examples (sort-of): Alto, TOPS-10, DOS FAT**
- **Pros?**
 - Easy dynamic growth & sequential access, no fragmentation
- **Cons?**
 - Linked lists on disk a bad idea because of access times
 - Random very slow (e.g., traverse whole file to find last block)
 - Pointers take up room in block, skewing alignment

Example: DOS FS (simplified)

- **Linked files with key optimization: puts links in fixed-size “file allocation table” (FAT) rather than in the blocks.**

Directory (5)

a: 6
b: 2

FAT (16-bit entries)

0	free
1	eof
2	1
3	eof
4	3
5	eof
6	4
	...

file a

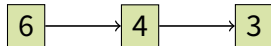

file b

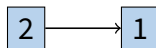

- **Still do pointer chasing, but can cache entire FAT so can be cheap compared to disk access**

FAT discussion

- **Entry size = 16 bits**
 - What's the maximum size of the FAT?
 - Given a 512 byte block, what's the maximum size of FS?
 - One solution: go to bigger blocks. Pros? Cons?
- **Space overhead of FAT is trivial:**
 - 2 bytes / 512 byte block = $\sim 0.4\%$ (Compare to Unix)
- **Reliability: how to protect against errors?**
 - Create duplicate copies of FAT on disk
 - State duplication a very common theme in reliability
- **Bootstrapping: where is root directory?**
 - Fixed location on disk:



FAT discussion

- **Entry size = 16 bits**
 - What's the maximum size of the FAT? 65,536 entries
 - Given a 512 byte block, what's the maximum size of FS? 32 MiB
 - One solution: go to bigger blocks. Pros? Cons?
- **Space overhead of FAT is trivial:**
 - 2 bytes / 512 byte block = $\sim 0.4\%$ (Compare to Unix)
- **Reliability: how to protect against errors?**
 - Create duplicate copies of FAT on disk
 - State duplication a very common theme in reliability
- **Bootstrapping: where is root directory?**
 - Fixed location on disk:

FAT	(opt) FAT	root dir	...
-----	-----------	----------	-----

Another approach: Indexed files

- **Each file has an array holding all of its block pointers**
 - Just like a page table, so will have similar issues
 - Max file size fixed by array's size (static or dynamic?)
 - Allocate array to hold file's block pointers on file creation
 - Allocate actual blocks on demand using free list

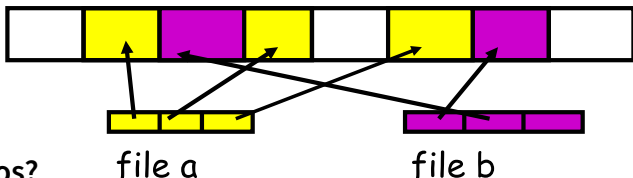

- **Pros?**
- **Cons?**

Another approach: Indexed files

- **Each file has an array holding all of its block pointers**
 - Just like a page table, so will have similar issues
 - Max file size fixed by array's size (static or dynamic?)
 - Allocate array to hold file's block pointers on file creation
 - Allocate actual blocks on demand using free list

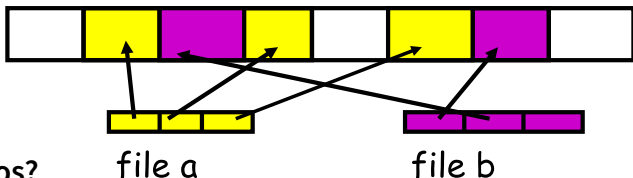

- **Pros?**
 - Both sequential and random access easy
- **Cons?**
 - Mapping table requires large chunk of contiguous space
... Same problem we were trying to solve initially

Indexed files

- Issues same as in page tables

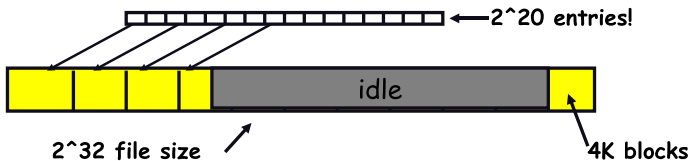

- Large possible file size = lots of unused entries
- Large actual size? table needs large contiguous disk chunk
- **Solve identically: small regions with index array, this array with another array, ...** Downside?



Multi-level indexed files (old BSD FS)

- Solve problem of first block access slow
- inode = 14 block pointers + “stuff”

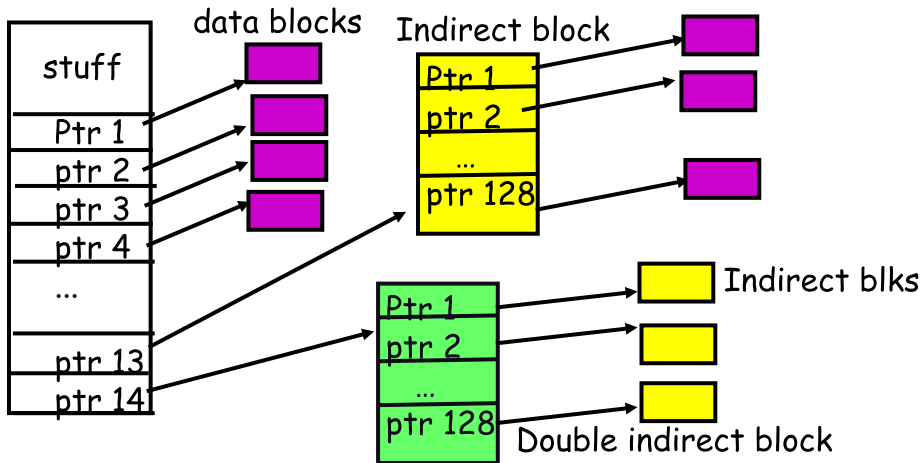

Old BSD FS discussion

- **Pros:**

- Simple, easy to build, fast access to small files
- Maximum file length fixed, but large.

- **Cons:**

- What is the worst case # of accesses?
- What is the worst-case space overhead? (e.g., 13 block file)

- **An empirical problem:**

- Because you allocate blocks by taking them off unordered freelist, metadata and data get strewn across disk

More about inodes

- **Inodes are stored in a fixed-size array**

- Size of array fixed when disk is initialized; can't be changed
- Lives in known location, originally at one side of disk:

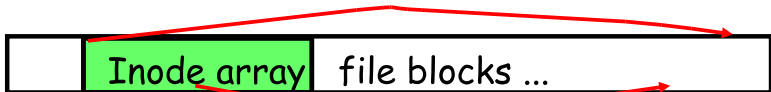

- Now is smeared across it (why?)

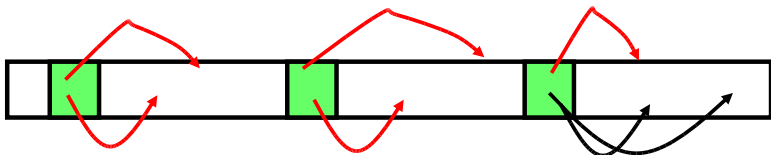

- The index of an inode in the inode array called an i-number
- Internally, the OS refers to files by inumber
- When file is opened, inode brought in memory
- Written back when modified and file closed or time elapses

Directories

- **Problem:**
 - “Spend all day generating data, come back the next morning, want to use it.” – F. Corbató, on why files/dirs invented
- **Approach 0: Users remember where on disk their files are**
 - E.g., like remembering your social security or bank account #
- **Yuck. People want human digestible names**
 - We use directories to map names to file blocks
- **Next: What is in a directory and why?**

A short history of directories

- **Approach 1: Single directory for entire system**
 - Put directory at known location on disk
 - Directory contains $\langle \text{name}, \text{inumber} \rangle$ pairs
 - If one user uses a name, no one else can
 - Many ancient personal computers work this way
- **Approach 2: Single directory for each user**
 - Still clumsy, and 1s on 10,000 files is a real pain
- **Approach 3: Hierarchical name spaces**
 - Allow directory to map names to files *or other dirs*
 - File system forms a tree (or graph, if links allowed)
 - Large name spaces tend to be hierarchical (ip addresses, domain names, scoping in programming languages, etc.)

Hierarchical Unix

- **Used since CTSS (1960s)**

- Unix picked up and used really nicely

- **Directories stored on disk just like regular files**

- Special inode type byte set to directory
- Users can read just like any other file (historically)
- Only special syscalls can write (why?)
- Inodes at fixed disk location
- File pointed to by the index may be another directory
- Makes FS into hierarchical tree (what needed to make a DAG?)

- **Simple, plus speeding up file ops speeds up dir ops!**



```
<name,inode#>
```

```
<afs,1021>
```

```
<tmp,1020>
```

```
<bin,1022>
```

```
<cdrom,4123>
```

```
<dev,1001>
```

```
<sbin,1011>
```

```
⋮
```

Naming magic

- **Bootstrapping: Where do you start looking?**
 - Root directory always inode #2 (0 and 1 historically reserved)
- **Special names:**
 - Root directory: “/” (fixed by kernel—e.g., inode 2)
 - Current directory: “.” (actual directory entry on disk)
 - Parent directory: “..” (actual directory entry on disk)
- **Some special names are provided by shell, not FS:**
 - User’s home directory: “~”
 - Globbing: “foo.*” expands to all files starting “foo.”
- **Using the given names, only need two operations to navigate the entire name space:**
 - `cd name`: move into (change context to) directory *name*
 - `ls`: enumerate all names in current directory (context)

Unix example: /a/b/c.c

"." Name space

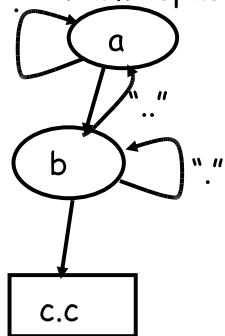

Physical organization

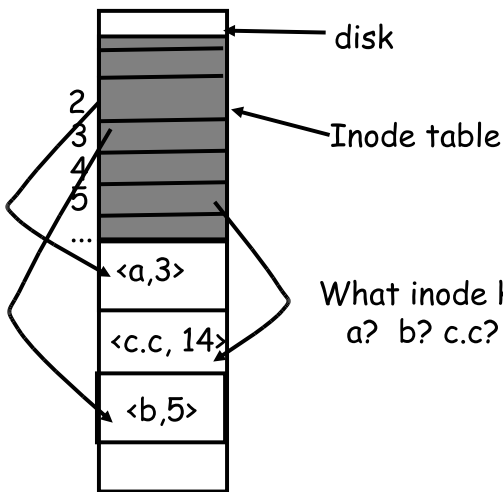

Default context: working directory

- **Cumbersome to constantly specify full path names**
 - In Unix, each process has a “current working directory” (cwd)
 - File names not beginning with “/” are assumed to be relative to cwd; otherwise translation happens as before
 - Editorial: root, cwd should be regular fds (like stdin, stdout, ...) with *openat* syscall instead of *open*
 - ▶ In modern linux *open* in libc calls *openat(AT_FDCWD, ...)* syscall
- **Shells track a default list of active contexts**
 - A “search path” for programs you run
 - Given a search path *A : B : C*, a shell will check in A, then check in B, then check in C
 - Can escape using explicit paths: “./foo”
- **Example of locality**

Hard and soft links (synonyms)

- **More than one dir entry can refer to a given file**

- Unix stores count of pointers (“hard links”) to inode
- To make: “`ln foo bar`” creates a synonym (`bar`) for *file* `foo`

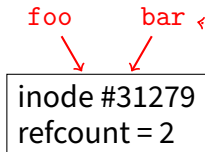

- **Soft/symbolic links = synonyms for *names***

- Point to a file (or dir) *name*, but object can be deleted from underneath it (or never even exist).
- Unix implements like directories: inode has special “symlink” bit set and contains name of link target

```
ln -s /bar baz
```

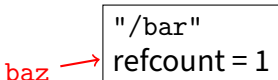

- When the file system encounters a symbolic link it automatically translates it (if possible).

Case study: speeding up FS

- **Original Unix FS: Simple and elegant:**

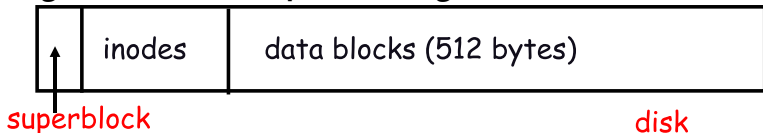

- **Components:**

- Data blocks
- Inodes (directories represented as files)
- Hard links
- Superblock. (specifies number of blks in FS, max # of files, pointer to head of free list)

- **Problem: slow**

- Only gets 20Kb/sec (2% of disk maximum) even for sequential disk transfers!

A plethora of performance costs

- **Blocks too small (512 bytes)**
 - File index too large
 - Too many layers of mapping indirection
 - Transfer rate low (get one block at time)
- **Poor clustering of related objects:**
 - Consecutive file blocks not close together
 - Inodes far from data blocks
 - Inodes for files in same directory not close together
 - Poor enumeration performance: e.g., “`ls -l`”, “`grep foo *.c`”
- **Usability problems**
 - 14-character file names a pain
 - Can't atomically update file in crash-proof way
- **Next: how FFS fixes these (to a degree) [McKusic]**

Problem: Internal fragmentation

- Block size was too small in Unix FS
- Why not just make block size bigger?

Block size	space wasted	file bandwidth
512	6.9%	2.6%
1024	11.8%	3.3%
2048	22.4%	6.4%
4096	45.6%	12.0%
1MB	99.0%	97.2%

- Bigger block increases bandwidth, but how to deal with wastage (“internal fragmentation”)?
 - Use idea from malloc: split unused portion.

Solution: fragments

- **BSD FFS:**

- Has large block size (4096 or 8192)
- Allow large blocks to be chopped into small ones (“fragments”)
- Used for little files and pieces at the ends of files

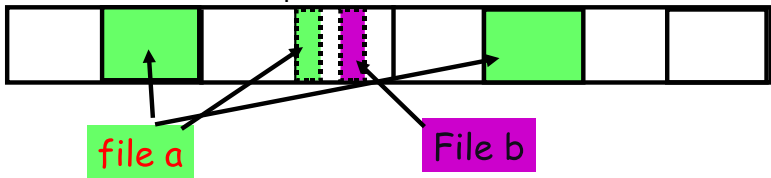

- **Best way to eliminate internal fragmentation?**

- Variable sized splits of course
- Why does FFS use fixed-sized fragments (1024, 2048)?

Clustering related objects in FFS

- Group sets of consecutive cylinders into “*cylinder groups*”

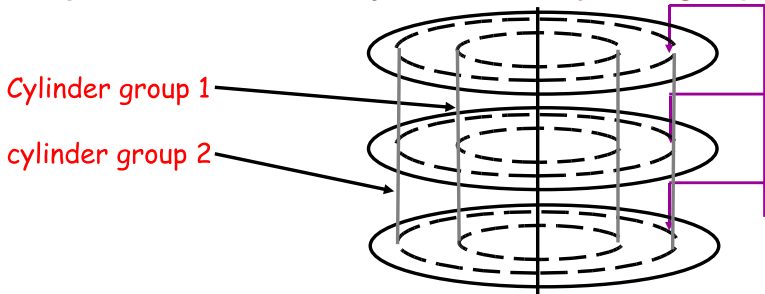

- Key: can access any block in a cylinder without performing a seek. Next fastest place is adjacent cylinder.
- Tries to put everything related in same cylinder group
- Tries to put everything not related in different group

Clustering in FFS

- Tries to put sequential blocks in adjacent sectors
 - (Access one block, probably access next)

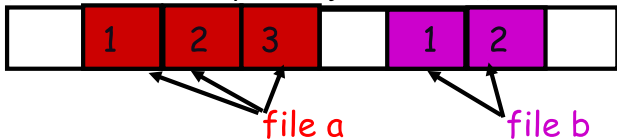

- Tries to keep inode in same cylinder group as file data:
 - (If you look at inode, most likely will look at data too)

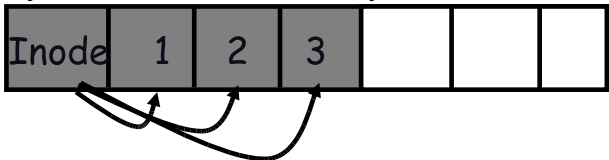

- Tries to keep all inodes in a dir in same cylinder group
 - Access one name, frequently access many, e.g., “ls -l”

What does disk layout look like?

- Each cylinder group basically a mini-Unix file system:

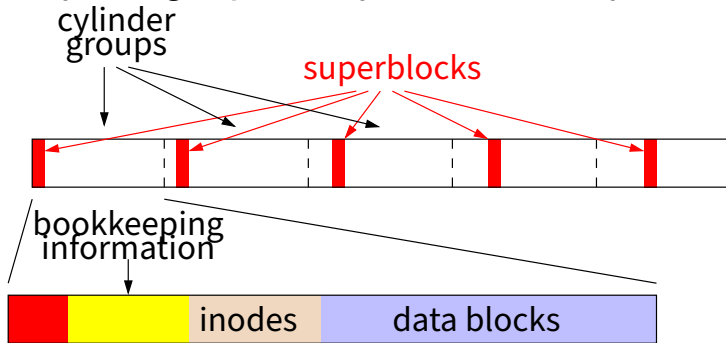

- How to ensure there's space for related stuff?
 - Place different directories in different cylinder groups
 - Keep a "free space reserve" so can allocate near existing things
 - When file grows too big (1MB) send its remainder to different cylinder group.

Finding space for related objs

- **Old Unix (& DOS): Linked list of free blocks**

- Just take a block off of the head. Easy.

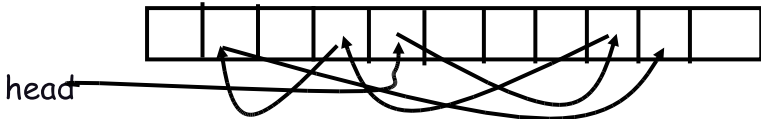

- Bad: free list gets jumbled over time. Finding adjacent blocks hard and slow

- **FFS: switch to bit-map of free blocks**

- 1010101111111000001111111000101100
- Easier to find contiguous blocks.
- Small, so usually keep entire thing in memory
- Time to find free block increases if fewer free blocks

Using a bitmap

- **Usually keep entire bitmap in memory:**
 - 4G disk / 4K byte blocks. How big is map?
- **Allocate block close to block x ?**
 - Check for blocks near `bmap[x/32]`
 - If disk almost empty, will likely find one near
 - As disk becomes full, search becomes more expensive and less effective
- **Trade space for time (search time, file access time)**
- **Keep a reserve (e.g, 10%) of disk always free, ideally scattered across disk**
 - Don't tell users (`df` can get to 110% full)
 - Only root can allocate blocks once FS 100% full
 - With 10% free, can almost always find one of them free

So what did we gain?

- **Performance improvements:**
 - Able to get 20-40% of disk bandwidth for large files
 - 10-20x original Unix file system!
 - Better small file performance (why?)
- **Is this the best we can do? No.**
- **Block based rather than extent based**
 - Could have named contiguous blocks with single pointer and length (Linux ext4fs, XFS)
- **Writes of metadata done synchronously**
 - Really hurts small file performance
 - Make asynchronous with write-ordering (“soft updates”) or logging/journaling... more next lecture
 - Play with semantics (/tmp file systems)

Other hacks

- **Obvious:**
 - Big file cache
- **Fact: no rotation delay if get whole track.**
 - How to use?
- **Fact: transfer cost negligible.**
 - Recall: Can get 50x the data for only $\sim 3\%$ more overhead
 - 1 sector: $5\text{ms} + 4\text{ms} + 5\mu\text{s}$ ($\approx 512\text{ B}/(100\text{ MB/s}) \approx 9\text{ms}$)
 - 50 sectors: $5\text{ms} + 4\text{ms} + .25\text{ms} = 9.25\text{ms}$
 - How to use?
- **Fact: if transfer huge, seek + rotation negligible**
 - **LFS:** Hoard data, write out MB at a time
- **Next lecture:**
 - FFS in more detail
 - More advanced, modern file systems